

# EXHIBIT A - PROJECT DATA

## PROJECT DATA

UNIT DATA											PRIVATE OS		PARKING		
PLAN	BR	FULL BA	HALF BA	DEN	FLR 1	FLR 2	FLR 3	UNIT FLR AREA	GARAGE	UNIT SF	UNIT FOOTPRINT	PATIO	DECK	REQ'D	PROVIDED
PLAN 1	3	3	1	1	310	822	761	1893	453	2346	763	195	72	2	2
PLAN 1.1	3	3	1	1	310	837	761	1908	468	2376	778	195	72	2	2
PLAN 1.2	3	3	1	1	323	829	866	2017	453	2470	776	191	89	2	2
PLAN 1.2R	3	3	1	1	323	817	864	2004	453	2457	776	191	89	2	2
PLAN 2@UNIT17	2	2	2	1	237	632	637	1507	457	1964	694	143	61	2	2
PLAN 3@UNIT18	2	2	2	1	235	632	637	1504	480	1984	715	89	61	2	2
PLAN 2@UNIT19	2	2	2	1	237	681	693	1611	457	2068	694	143	61	2	2
PLAN 3@UNIT20	2	2	2	1	235	632	637	1504	480	1984	715	143	61	2	2

BUILDING DATA											PRIVATE OS		PARKING			
BUILDING A											PATIO	DECK	REQ'D	PROVIDED		
PLAN	COUNT	BR	FULL BA	HALF BA	DEN	FLR 1	FLR 2	FLR 3	BLDG FLR AREA	BLDG GARAGE	BLDG SF	BLDG FOOTPRINT	PATIO	DECK	REQ'D	PROVIDED
PLAN 1	3	9	9	3	3	930	2466	2283	5679	1359	7038	2289	585	216	6	6
PLAN 1.1	2	6	6	2	2	620	1674	1522	3816	936	4752	1556	390	144	4	4
PLAN 1.2	2	6	6	2	2	646	1658	1732	4036	906	4942	1552	382	178	4	4
PLAN 1.2R	2	6	6	2	2	646	1634	1728	4008	906	4914	1552	382	178	4	4
TOTAL	9	27	27	9	9	2842	7432	7265	17539	4107	21646	6949	1739	716	18	18

BUILDING B											PRIVATE OS		PARKING			
PLAN	COUNT	BR	FULL BA	HALF BA	DEN	FLR 1	FLR 2	FLR 3	BLDG FLR AREA	BLDG GARAGE	BLDG SF	BLDG FOOTPRINT	PATIO	DECK	REQ'D	PROVIDED
PLAN 1	1	3	3	1	1	310	822	761	1893	453	2346	763	195	72	2	2
PLAN 1.1	2	6	6	2	2	620	1674	1522	3816	936	4752	1556	390	144	4	4
PLAN 1.2	1	3	3	1	1	323	829	866	2017	453	2470	776	191	89	2	2
PLAN 1.2R	1	3	3	1	1	323	817	864	2004	453	2457	776	191	89	2	2
TOTAL	5	15	15	5	5	1576	4142	4013	9730	2295	12025	3871	967	394	10	10

BUILDING C											PRIVATE OS		PARKING			
PLAN	COUNT	BR	FULL BA	HALF BA	DEN	FLR 1	FLR 2	FLR 3	BLDG FLR AREA	BLDG GARAGE	BLDG SF	BLDG FOOTPRINT	PATIO	DECK	REQ'D	PROVIDED
PLAN 1	1	3	3	1	1	310	822	761	1893	453	2346	763	195	72	2	2
PLAN 1.1	1	3	3	1	1	310	837	761	1908	468	2376	778	195	72	2	2
PLAN 2@UNIT17	1	2	2	2	1	237	632	637	1506	453	1959	690	143	61	2	2
PLAN 3@UNIT18	1	2	2	2	1	235	632	637	1504	453	1957	688	89	61	2	2
TOTAL	4	10	10	6	4	1092	2923	2796	6811	1827	8638	2919	622	266	8	8

BUILDING D											PRIVATE OS		PARKING			
PLAN	COUNT	BR	FULL BA	HALF BA	DEN	FLR 1	FLR 2	FLR 3	BLDG FLR AREA	BLDG GARAGE	BLDG SF	BLDG FOOTPRINT	PATIO	DECK	REQ'D	PROVIDED
PLAN 2@UNIT19	1	2	2	2	1	237	681	693	1611	457	2068	694	143	61	2	2
PLAN 3@UNIT20	1	2	2	2	1	235	632	637	1504	480	1984	715	143	61	2	2
TOTAL	2	4	4	4	2	472	1313	1330	3115	937	4052	1409	286	122	4	4

SURFACE PARKING											PRIVATE OS		PARKING			
SITE TOTAL	COUNT	BR	FULL BA	HALF BA	DEN	FLR 1	FLR 2	FLR 3	BLDG FLR AREA	BLDG GARAGE	BLDG SF	BLDG FOOTPRINT	PATIO	DECK	REQ'D	PROVIDED
	20	56	56	24	20	5982	15810	15404	37195	9166	46361	15148	3614	1498	9	5
								AVG UNIT SF		AVG UNIT SF						
								1860	(INCL GARAGE)	2318						

## DRAWING INDEX

CS - COVER SHEET  
 RENDERING #1  
 RENDERING #2  
 A0.1 - DRAWING INDEX

### CIVIL:

C1 - TITLE SHEET & SITE PLAN  
 C2 - TOPOGRAPHY SURVEY  
 C3 - DIMENSIONED SITE PLAN AND TREE PRESERVATION  
 C4 - GRADING AND UTILITY PLAN  
 C5 - GRADING AND UTILITY PLAN  
 C6 - PRELIMINARY C3 STORM WATER CONTROL PLAN  
 C7 - SECTIONS

### LANDSCAPE:

L-1.0 - NOTES AND LEGENDS  
 L-3.0 - LAYOUT PLAN  
 L-3.1 - DETAIL PLAN  
 L-4.0 - DETAILS  
 L-4.1 - DETAILS  
 L-4.2 - DETAILS  
 L-4.3 - DETAILS  
 L-6.0 - PLANTING NOTES AND LEGENDS  
 L-6.1 - PLANTING PLAN  
 L-6.2 - PLANTING DETAILS  
 L-7.1 - LIGHTING PLAN

### ARCHITECTURAL:

A0.2 - SITE PLAN  
 A0.2A - FIRE LANE DIAGRAM  
 A0.3 - STREETScape  
 A0.4 - COLOR RENDERING  
 A1.1 - BLDG. A GROUND FLOOR PLAN  
 A1.2 - BLDG. A MAIN FLOOR PLAN  
 A1.3 - BLDG. A UPPER FLOOR PLAN  
 A1.4 - BLDG. A ROOF PLAN  
 A1.5 - BLDG. A FRONT ELEVATION  
 A1.6 - BLDG. A REAR ELEVATION  
 A1.7 - BLDG. A SIDE ELEVATIONS  
 A2.1 - BLDG. B GROUND FLOOR PLAN  
 A2.2 - BLDG. B MAIN FLOOR PLAN  
 A2.3 - BLDG. B UPPER FLOOR PLAN  
 A2.4 - BLDG. B ROOF PLAN  
 A2.5 - BLDG. B FRONT & LEFT ELEVATIONS  
 A2.6 - BLDG. B REAR & RIGHT ELEVATIONS  
 A3.1 - BLDG. C GROUND FLOOR PLAN  
 A3.2 - BLDG. C MAIN FLOOR PLAN  
 A3.3 - BLDG. C UPPER FLOOR PLAN  
 A3.4 - BLDG. C ROOF PLAN  
 A3.5 - BLDG. C FRONT & LEFT ELEVATIONS  
 A3.6 - BLDG. C REAR & RIGHT ELEVATIONS  
 A4.1 - BLDG. D FLOOR PLANS & ROOF PLAN  
 A4.2 - BLDG. D ELEVATIONS  
 A5.1 - PLAN 1  
 A5.2 - PLAN 1.1  
 A5.3 - PLAN 1.2  
 A5.4 - PLAN 1.2  
 A5.5 - PLAN 2&3  
 A5.6 - PLAN 2&3

## PROJECT DATA

SITE ADDRESS:  
 311 MACARTHUR BLVD.  
 SAN LEANDRO, CA

LOT SIZE: ±42,444 SQ. FT.

ZONING: CC  
 OCCUPANCY CLASSIFICATION: R2

BUILDINGS: 4  
 UNITS: 20  
 COVERED PARKING SPACE: 40  
 GUEST PARKING: 5  
 STREET PARKING: +10

PROJECTED BUILDING TYPE: VB  
 PROJECTED FIRE PROTECTION: NFPA 13R  
 PROJECTED ALARM SYSTEM: NFPA 72

\*PATH AND WALK WAYS TO THE PUBLIC WAY  
 TO BE PROVIDED WITH EMERGENCY  
 LIGHTING. FINAL DESIGN TBD.

## ARCHITECT

HUNT HALE JONES ARCHITECTS

444 SPEAR STREET, SUITE 200  
 SAN FRANCISCO, CA 94105  
 PHONE: (415) 512-1300  
 FAX: (415) 288-0288

## DEVELOPER

DAVID LANGON CONSTRUCTION, INC.

3189 DANVILLE BLVD., SUITE 245  
 ALAMO, CA 94507  
 PHONE: (510) 368-3263

## LANDSCAPE ARCHITECT

LEVESQUE DESIGN

1414 BAY STREET, SUITE 100  
 ALAMEDA, CA 94501  
 PHONE: (510) 521-6700

## CIVIL ENGINEER

APEX CIVIL ENGINEERING & LAND SURVEYING

817 ARNOLD DRIVE, SUITE 50  
 MARTINEZ, CA 94553  
 PHONE: (925) 639-5635

# BROADMOOR VILLAGE

311 MACARTHUR BLVD.  
 SAN LEANDRO, CA



Architecture | Planning | Interiors

444 Spear Street, Suite 105  
 San Francisco, CA 94105  
 www.hunthalejones.com

t. 415-512-1300  
 f. 415-288-0288

DRAWING INDEX

# A0.1

SCALE: N.T.S.

DATE: 05.22.2017  
 REVISED DATE: 01.02.2019  
 PROJECT: 335005.00

# EXHIBIT B - SITE PLAN

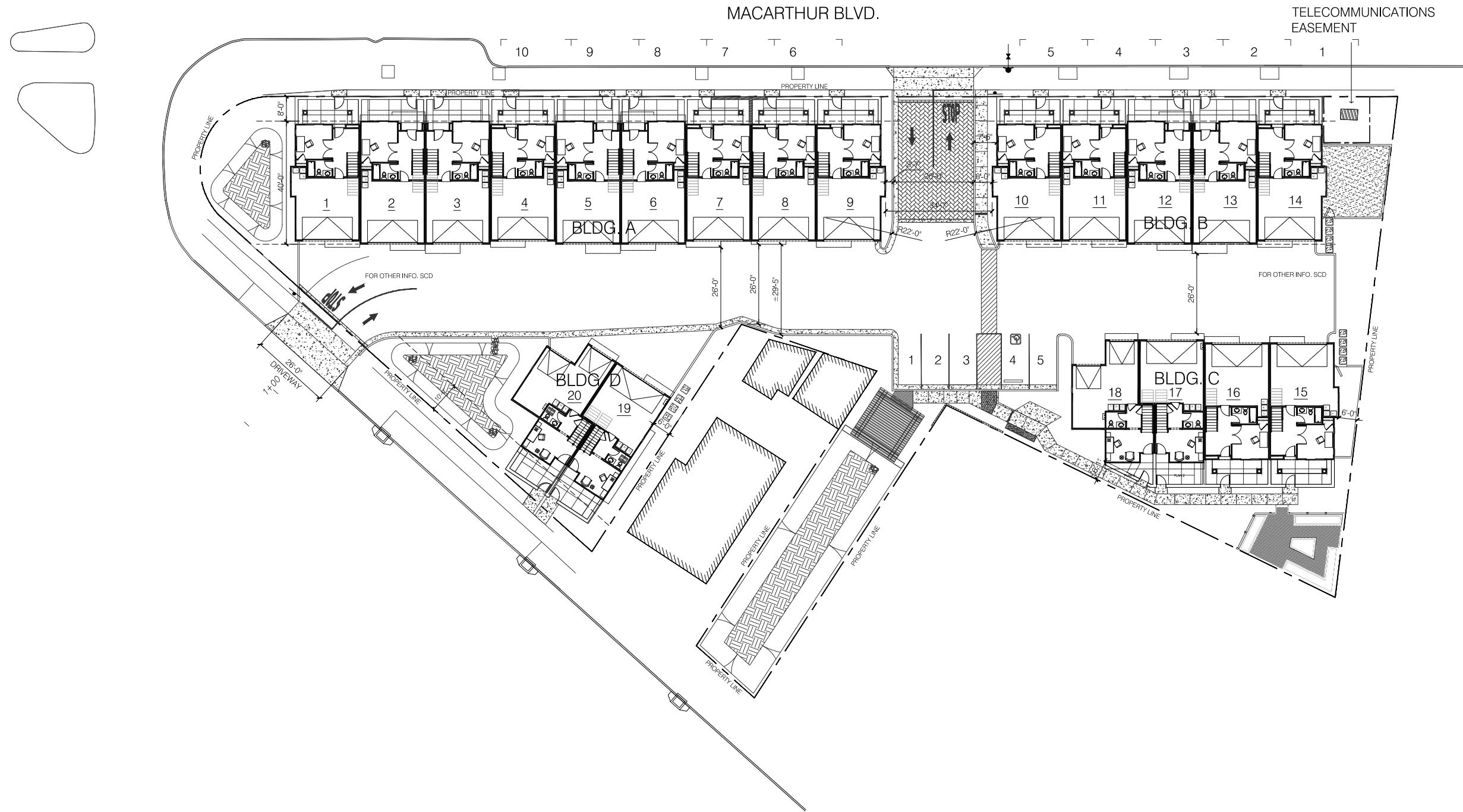

## BROADMOOR VILLAGE

311 MACARTHUR BLVD.  
SAN LEANDRO, CA



Architecture | Planning | Interiors

444 Spear Street, Suite 105  
San Francisco, CA 94105  
www.hunthalejones.com

t. 415-512-1300  
f. 415-288-0288

SITE PLAN

A0.2

SCALE: 1/16" = 1'-0"  
DATE: 05.22.2017  
REVISED DATE: 01.02.2019  
PROJECT: 335005.00

# EXHIBIT C - LANDSCAPE LAYOUT PLAN

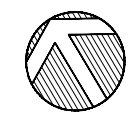
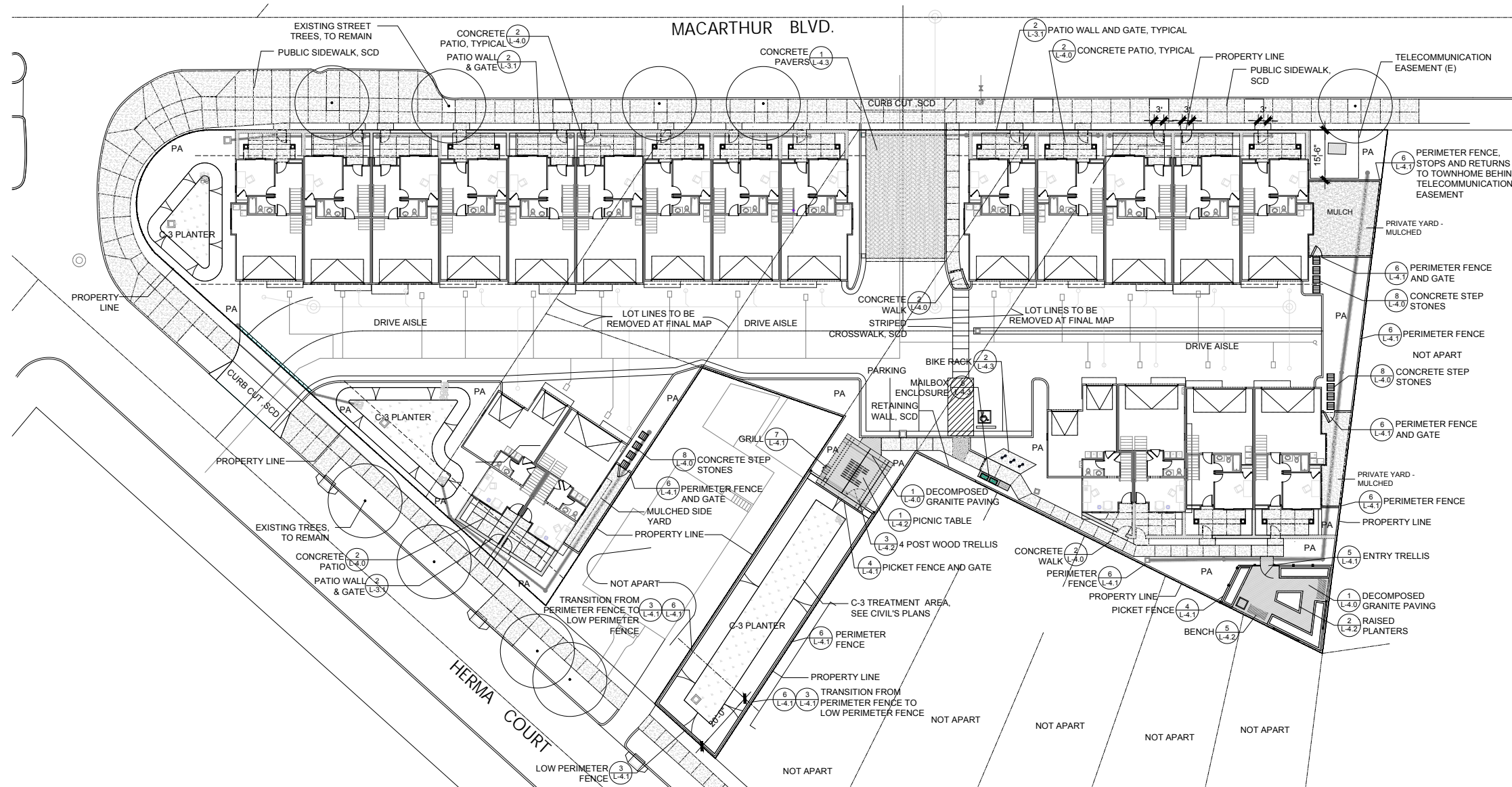

<p><b>Broadmoor Village</b>          311 MacArthur Blvd. LLC          311 MacArthur Blvd.          San Leandro, California</p>	<p><b>LAYOUT PLAN</b>  <b>L-3.0</b></p>	 <p><b>LEVESQUE DESIGN</b>          1414 BAY STREET, SUITE 100          ALAMEDA, CALIFORNIA 94501          (510) 521 6700</p>	<p>DATE: 10/08/2018          PROJECT: 17-142</p>
--	---	--	--

# EXHIBIT D - DIMENSIONED SITE PLAN, SIGNING, STRIPING, TREE PRESERVATION

## DIMENSIONED SITE PLAN, SIGNING AND STRIPING AND TREE PRESERVATION BROADMOOR VILLAGE (TRACT 8422) MULTI-FAMILY RESIDENTIAL CITY OF SAN LEANDRO, ALAMEDA COUNTY, CALIFORNIA



817 Arnold Drive, Ste. 50  
Martinez, CA 94553  
Ph: 925-476-8499  
www.apexce.net



GRAPHIC SCALE  
( IN FEET )  
1 inch = 20 ft.

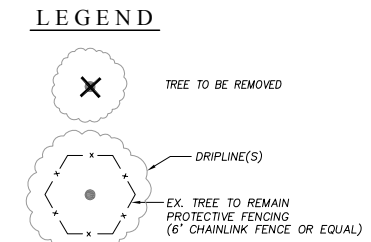
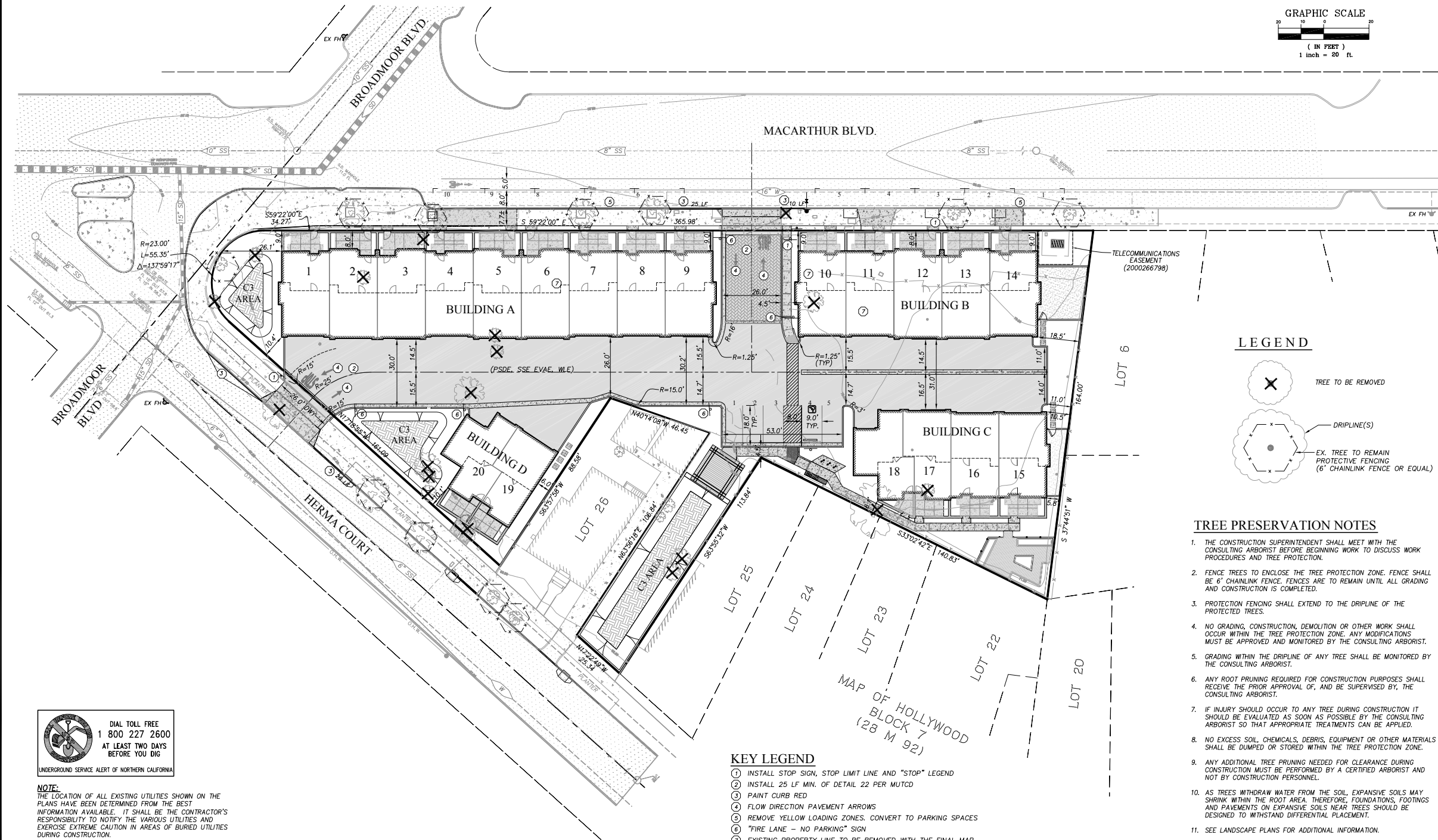

### TREE PRESERVATION NOTES

1. THE CONSTRUCTION SUPERINTENDENT SHALL MEET WITH THE CONSULTING ARBORIST BEFORE BEGINNING WORK TO DISCUSS WORK PROCEDURES AND TREE PROTECTION.
2. FENCE TREES TO ENCLOSE THE TREE PROTECTION ZONE. FENCE SHALL BE 6" CHAINLINK FENCE. FENCES ARE TO REMAIN UNTIL ALL GRADING AND CONSTRUCTION IS COMPLETED.
3. PROTECTION FENCING SHALL EXTEND TO THE DRIPLINE OF THE PROTECTED TREES.
4. NO GRADING, CONSTRUCTION, DEMOLITION OR OTHER WORK SHALL OCCUR WITHIN THE TREE PROTECTION ZONE. ANY MODIFICATIONS MUST BE APPROVED AND MONITORED BY THE CONSULTING ARBORIST.
5. GRADING WITHIN THE DRIPLINE OF ANY TREE SHALL BE MONITORED BY THE CONSULTING ARBORIST.
6. ANY ROOT PRUNING REQUIRED FOR CONSTRUCTION PURPOSES SHALL RECEIVE THE PRIOR APPROVAL OF, AND BE SUPERVISED BY, THE CONSULTING ARBORIST.
7. IF INJURY SHOULD OCCUR TO ANY TREE DURING CONSTRUCTION IT SHOULD BE EVALUATED AS SOON AS POSSIBLE BY THE CONSULTING ARBORIST SO THAT APPROPRIATE TREATMENTS CAN BE APPLIED.
8. NO EXCESS SOIL, CHEMICALS, DEBRIS, EQUIPMENT OR OTHER MATERIALS SHALL BE DUMPED OR STORED WITHIN THE TREE PROTECTION ZONE.
9. ANY ADDITIONAL TREE PRUNING NEEDED FOR CLEARANCE DURING CONSTRUCTION MUST BE PERFORMED BY A CERTIFIED ARBORIST AND NOT BY CONSTRUCTION PERSONNEL.
10. AS TREES WITHDRAW WATER FROM THE SOIL, EXPANSIVE SOILS MAY SHRINK WITHIN THE ROOT AREA. THEREFORE, FOUNDATIONS, FOOTINGS AND PAVEMENTS ON EXPANSIVE SOILS NEAR TREES SHOULD BE DESIGNED TO WITHSTAND DIFFERENTIAL PLACEMENT.
11. SEE LANDSCAPE PLANS FOR ADDITIONAL INFORMATION.

### KEY LEGEND

- ① INSTALL STOP SIGN, STOP LIMIT LINE AND "STOP" LEGEND
- ② INSTALL 25 LF MIN. OF DETAIL 22 PER MUTCD
- ③ PAINT CURB RED
- ④ FLOW DIRECTION PAVEMENT ARROWS
- ⑤ REMOVE YELLOW LOADING ZONES. CONVERT TO PARKING SPACES
- ⑥ "FIRE LANE - NO PARKING" SIGN
- ⑦ EXISTING PROPERTY LINE TO BE REMOVED WITH THE FINAL MAP



**NOTE:**  
THE LOCATION OF ALL EXISTING UTILITIES SHOWN ON THE PLANS HAVE BEEN DETERMINED FROM THE BEST INFORMATION AVAILABLE. IT SHALL BE THE CONTRACTOR'S RESPONSIBILITY TO NOTIFY THE VARIOUS UTILITIES AND EXERCISE EXTREME CAUTION IN AREAS OF BURIED UTILITIES DURING CONSTRUCTION.

NO.	REVISIONS	BY	DATE

TENTATIVE MAP  
DIMENSIONED SITE PLAN AND TREE PRESERVATION  
BROADMOOR VILLAGE (TRACT 8422)  
SAN LEANDRO, CA

SHEET  
C3

DATE  
10-09-2018

PROJECT #: 17028

# EXHIBIT E - FIRE LANE DIAGRAM

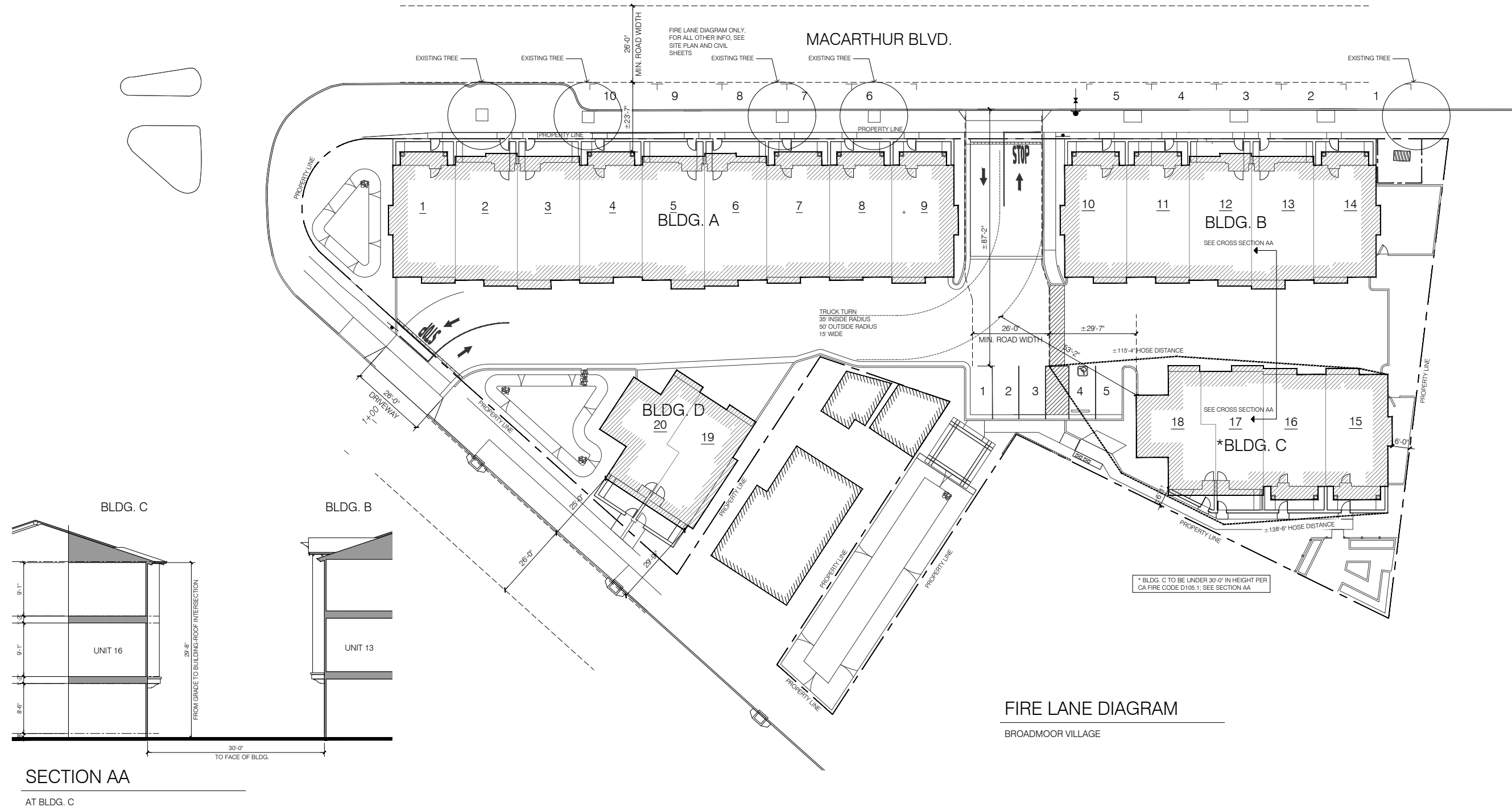

**BROADMOOR VILLAGE**  
311 MACARTHUR BLVD.  
SAN LEANDRO, CA



Architecture | Planning | Interiors

444 Spear Street, Suite 105  
San Francisco, CA 94105  
www.hunthalejones.com

t. 415-512-1300  
f. 415-288-0288

FIRE LANE DIAGRAM

**A0.2A**

SCALE: 1/16" = 1'-0"  
DATE: 05.22.2017  
REVISED DATE: 01.02.2019  
PROJECT: 335005.00

# EXHIBIT F - LIGHTING PLAN

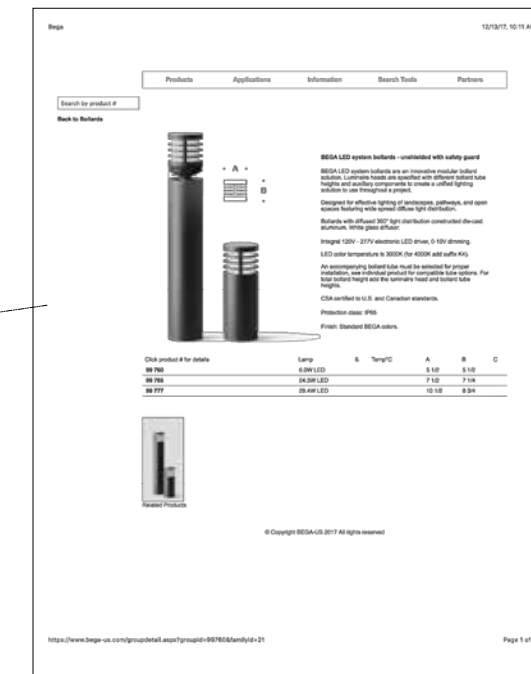
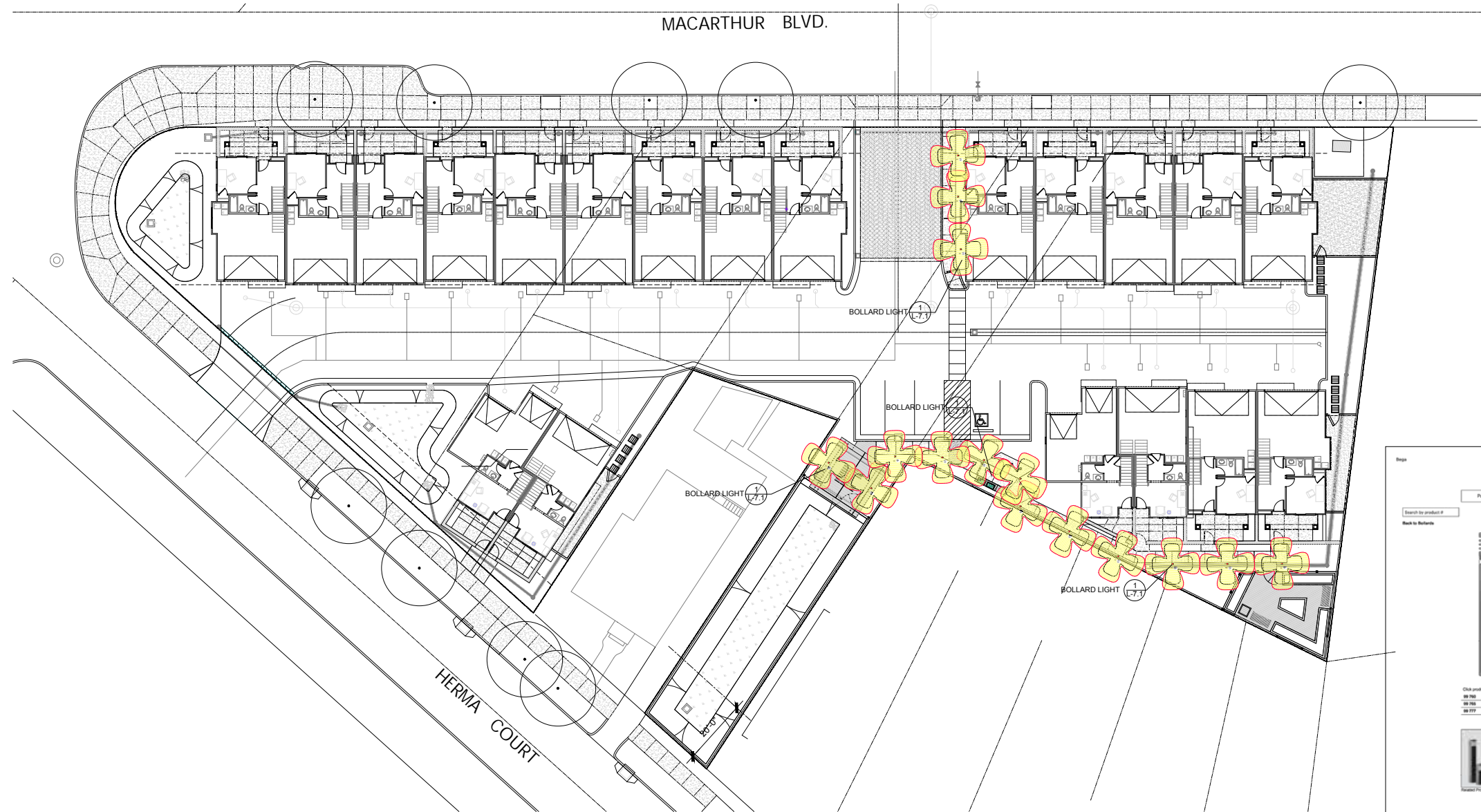

1 BOLLARD LIGHT

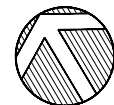

## Broadmoor Village

311 MacArthur Blvd. LLC

311 MacArthur Blvd.

San Leandro, California

## LIGHTING PLAN

### L-7.1



LEVESQUE DESIGN

1414 BAY STREET, SUITE 100  
 ALAMEDA, CALIFORNIA 94501  
 (510) 521 6700

DATE: 10/08/2018  
 PROJECT: 17-142

# EXHIBIT G - TENTATIVE MAP TRACT 8422

## TENTATIVE MAP BROADMOOR VILLAGE (TRACT 8422) MULTI-FAMILY RESIDENTIAL CITY OF SAN LEANDRO, ALAMEDA COUNTY, CALIFORNIA

### OWNER / DEVELOPER

311 MACARTHUR BLVD, LLC  
6114 LA SALLE AVE # 535  
OAKLAND, CA. 94611  
510-339-9905

### CIVIL ENGINEER

APEX CIVIL ENGINEERING & LAND SURVEYING  
817 ARNOLD DRIVE, SUITE 50  
MARTINEZ, CA 94553  
(925) 476-8499

### ARCHITECT

HUNT HALE JONES  
444 SPEAR STREET, SUITE 105  
SAN FRANCISCO, CA 94105  
(415) 512-1300

### LANDSCAPE ARCHITECT

LEVESQUE DESIGN  
1414 BAY STREET, SUITE 100  
ALAMEDA, CA 94501  
(510) 521-6700

### ABBREVIATIONS

AB	-	AGGREGATE BASE
AC	-	ACRE
AD	-	AREA DRAIN
BW	-	BOTTOM OF WALL
CB	-	CATCH BASIN
CONC	-	CONCRETE
CL	-	CENTER LINE
DET	-	DETAIL
DU	-	DWELLING UNITS
DWG	-	DRAWING
DWY	-	DRIVEWAY
EG	-	EXISTING GROUND
EX	-	EXISTING
FF	-	FINISH FLOOR
FG	-	FINISH GRADE
FL	-	FLOW LINE ELEVATION
G	-	GRATE ELEVATION
GB	-	GRADE BREAK
GFF	-	GARAGE FLOOR
GL	-	GARAGE LIP ELEVATION
HP	-	HIGH POINT
INV	-	INVERT
LF	-	LINEAR FEET
MAX	-	MAXIMUM
MH	-	MANHOLE
MIN	-	MINIMUM
NTS	-	NOT TO SCALE
P	-	PAD
R	-	PROPERTY LINE
PVC	-	POLYVINYL CHLORIDE
RCP	-	REINFORCED CONCRETE PIPE
R/W	-	RIGHT OF WAY
SD	-	STORM DRAIN
SDWK	-	SIDEWALK
STD	-	STANDARDS
SF	-	SQUARE FEET
SSCO	-	SEWER CLEANOUT
SDMH	-	STORM DRAIN MANHOLE
SSMH	-	SANITARY SEWER MANHOLE
STD	-	STANDARD
TC	-	TOP OF CURB
TSL	-	TOP OF SOIL LAYER
TW	-	TOP OF WALL
TYP	-	TYPICAL

### LEGEND

	LOT BOUNDARY
	RIGHT-OF-WAY
	CENTERLINE
	ADJACENT PROPERTY LINE
	NEW BUILDING
	EX. BUILDING
	EX. ASPHALT
	NEW ASPHALT
	NEW CONCRETE
	BIO RETENTION AREA
	FINISHED SPOT GRADE
	FINISHED GRADE SLOPE
	DIRECTION OF DRAINAGE FLOW
	EX. TREE
	STORM DRAIN LINE
	KEYSTONE RETAINING WALL OR APPROVED EQUAL

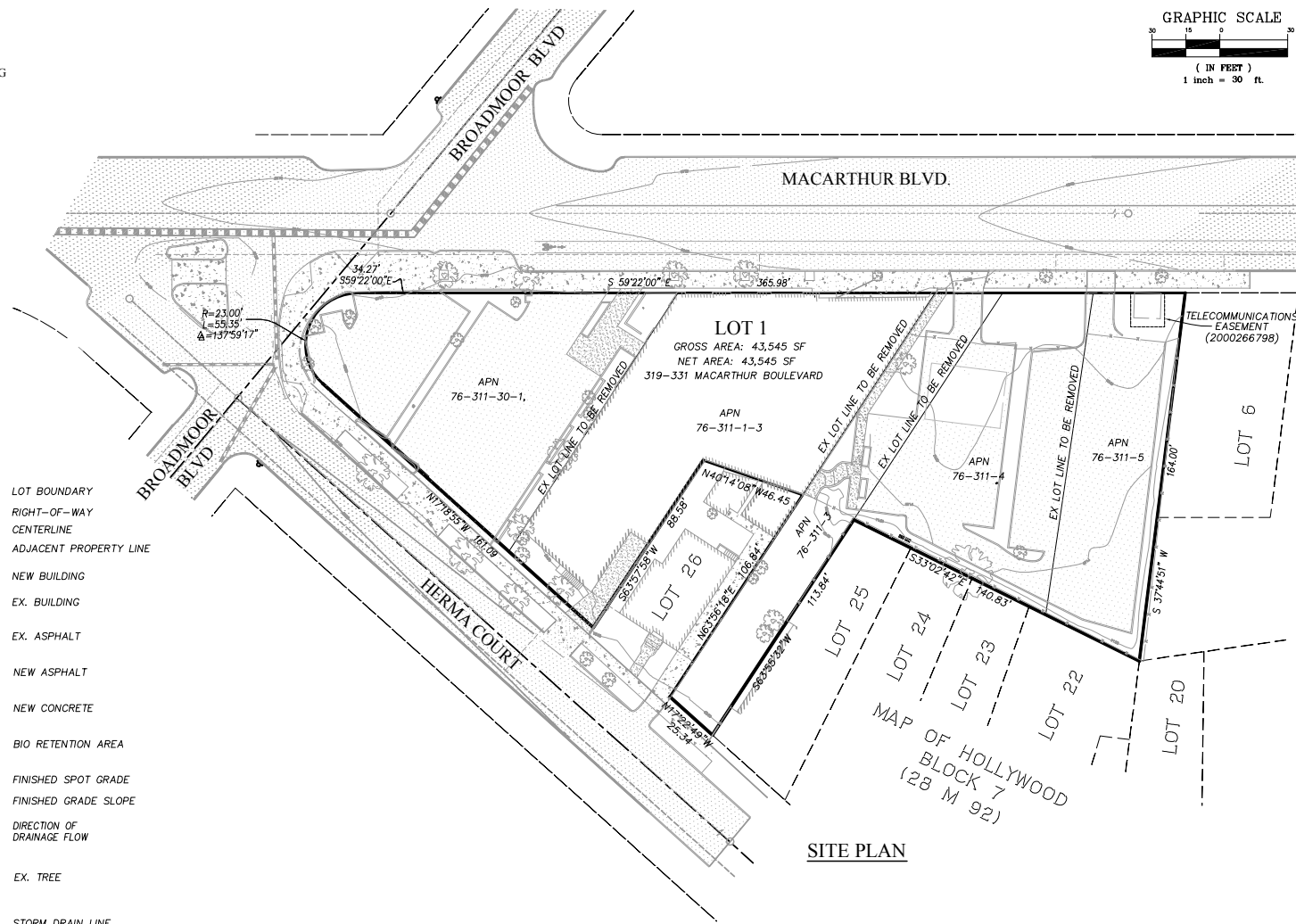

SHEET No.	DESCRIPTION
C1	TITLE SHEET & SITE PLAN
C2	TOPOGRAPHIC SURVEY
C3	DIMENSIONED SITE PLAN AND TREE PRESERVATION
C4-C5	PRELIMINARY GRADING AND UTILITY PLAN
C6	PRELIMINARY C.3 STORM WATER CONTROL PLAN
C7	SECTIONS

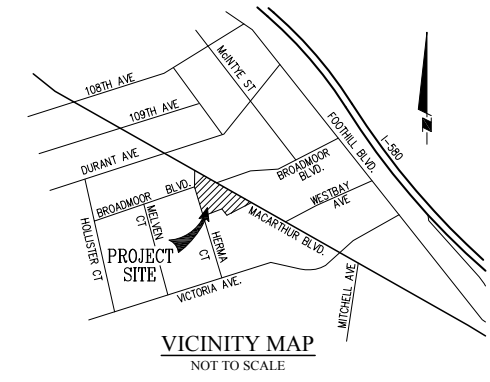
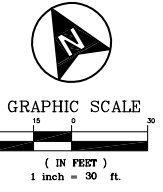

### GENERAL

ASSESSORS PARCEL NO:	APN'S 76-311-30-1, 76-311-1-3, 76-311-3,4,5
PROJECT ADDRESS:	319-331 MACARTHUR BOULEVARD SAN LEANDRO, CA
GROSS AREA:	43,545 SF
NET AREA:	43,545 SF
EXISTING USE:	COMMERCIAL
EXISTING ZONING:	CC - COMMERCIAL COMMUNITY DISTRICT
EXISTING GENERAL PLAN DESIGNATION:	CORRIDOR MIXED USE
MAXIMUM BUILDING HEIGHT:	35'
PROPOSED USE:	MULTI-FAMILY RESIDENTIAL
PROPOSED ZONING:	CC(PD)
NUMBER OF UNITS:	1 LOT - 20 CONDOMINIUM UNITS
GROSS DENSITY:	20 DWELLING UNITS/ACRE
FEMA FLOOD DESIGNATION:	ZONE 'X', #06001C02576, DATED 08-03-09
EXISTING TOPOGRAPHY DATE:	OCTOBER 2016, BAY AREA LAND SURVEYING
FIRE DEPARTMENT:	ALAMEDA COUNTY FIRE DEPARTMENT

### FACILITIES

WATER:	EAST BAY MUNICIPAL UTILITY DISTRICT (EBMUD)
SEWER:	CITY OF SAN LEANDRO
STORM DRAIN:	CITY OF SAN LEANDRO
GAS & ELECTRIC:	PACIFIC GAS & ELECTRIC
TELEPHONE:	BROADBAND COMPARISON

### NOTES

- NO PUBLIC AREAS ARE PROPOSED.
- NO NEW STREET NAMES ARE PROPOSED.

### BASIS OF ELEVATIONS

NAIL IN TOP-OF-CURB AT THE EAST RETURN OF THE NORTH-EAST CORNER OF THE INTERSECTION OF MACARTHUR BLVD. & VICTORIA AVE. ELEVATION = 72.66 PER CITY OF SAN LEANDRO DATUM.

### BASIS OF BEARINGS

SOUTHERLY RIGHT-OF-WAY LINE, OF MACARTHUR BLVD. TAKEN AS S59°22'E AS SHOWN ON MAP OF HOLLYWOOD, (28 M. 92).

### SURVEY NOTE

TOPOGRAPHIC SURVEY DATA IS BASED ON A SURVEY FILE PROVIDED BY BAY AREA LAND SURVEYING, DATED OCTOBER 2016.



817 Arnold Drive, Ste. 50  
Martinez, CA 94553  
Ph: (925) 476-8499  
www.apexce.net



NO.	REVISIONS	BY	DATE

TENTATIVE MAP  
TITLE SHEET  
BROADMOOR VILLAGE (TRACT 8422)  
SAN LEANDRO, CA

SHEET C1
DATE 10-09-2018
PROJECT #: 17028

BROADMOOR VILLAGE (TRACT 8422) ~ TENTATIVE MAP ~ 10-09-2018

# EXHIBIT H.1 - BUILDING A FRONT ELEVATION



BUILDING A FRONT ELEVATION

BUILDING A - BROADMOOR VILLAGE

## BROADMOOR VILLAGE

311 MACARTHUR BLVD.  
SAN LEANDRO, CA



Architecture | Planning | Interiors

444 Spear Street, Suite 105  
San Francisco, CA 94105  
www.hunthalejones.com

t. 415-512-1300  
f. 415-288-0288

BLDG. A FRONT ELEVATION

### A1.5

SCALE: 1/8" = 1'-0"  
DATE: 05.22.2017  
REVISED DATE: 01.02.2019  
PROJECT: 335005.00



# EXHIBIT H.2 - BUILDING A REAR ELEVATION



BUILDING A REAR ELEVATION

BUILDING A - BROADMOOR VILLAGE

## BROADMOOR VILLAGE

311 MACARTHUR BLVD.  
SAN LEANDRO, CA



Architecture | Planning | Interiors

444 Spear Street, Suite 105  
San Francisco, CA 94105  
www.hunthalejones.com

t. 415-512-1300  
f. 415-288-0288

BLDG. A REAR ELEVATION

### A1.6

SCALE: 1/8" = 1'-0"  
DATE: 05.22.2017  
REVISED DATE: 01.02.2019  
PROJECT: 335005.00

# EXHIBIT H.3 - BUILDING A LEFT/RIGHT ELEVATIONS



BUILDING A LEFT ELEVATION

BUILDING A - BROADMOOR VILLAGE



BUILDING A RIGHT ELEVATION

BUILDING A - BROADMOOR VILLAGE

## BROADMOOR VILLAGE

311 MACARTHUR BLVD.  
SAN LEANDRO, CA



Architecture | Planning | Interiors

444 Spear Street, Suite 105  
San Francisco, CA 94105  
www.hunthalejones.com

t. 415-512-1300  
f. 415-288-0288

BLDG. A SIDE ELEVATIONS

A1.7

SCALE: 1/8" = 1'-0"  
DATE: 05.22.2017  
REVISED DATE: 01.02.2019  
PROJECT: 335005.00

# EXHIBIT H.4 - BUILDING B FRONT/LEFT ELEVATIONS



BUILDING B FRONT ELEVATION

BUILDING B - BROADMOOR VILLAGE



BUILDING B LEFT ELEVATION

BUILDING B - BROADMOOR VILLAGE

## BROADMOOR VILLAGE

311 MACARTHUR BLVD.  
SAN LEANDRO, CA



Architecture | Planning | Interiors

444 Spear Street, Suite 105  
San Francisco, CA 94105  
www.hunthalejones.com

t. 415-512-1300  
f. 415-288-0288

BLDG. B FRONT & LEFT ELEVATIONS

A2.5

SCALE: 1/8" = 1'-0"  
DATE: 05.22.2017  
REVISED DATE: 01.02.2019  
PROJECT: 335005.00

# EXHIBIT H.5 - BUILDING B REAR/RIGHT ELEVATIONS



BUILDING B REAR ELEVATION

BUILDING B - BROADMOOR VILLAGE



BUILDING B RIGHT ELEVATION

BUILDING B - BROADMOOR VILLAGE

BROADMOOR VILLAGE

311 MACARTHUR BLVD.  
SAN LEANDRO, CA



Architecture | Planning | Interiors

444 Spear Street, Suite 105  
San Francisco, CA 94105  
www.hunthalejones.com

t. 415-512-1300  
f. 415-288-0288

BLDG. B REAR & RIGHT ELEVATIONS

A2.6

SCALE: 1/8" = 1'-0"  
DATE: 05.22.2017  
REVISED DATE: 01.02.2019  
PROJECT: 335005.00

# EXHIBIT H.6 - BUILDING C FRONT/LEFT ELEVATIONS



BUILDING C FRONT ELEVATION

BUILDING C - BROADMOOR VILLAGE



BUILDING C LEFT ELEVATION

BUILDING C - BROADMOOR VILLAGE

BROADMOOR VILLAGE

311 MACARTHUR BLVD.

SAN LEANDRO, CA



Architecture | Planning | Interiors

444 Spear Street, Suite 105  
San Francisco, CA 94105  
www.hunthalejones.com

t. 415-512-1300  
f. 415-288-0288

BLDG. C FRONT & LEFT ELEVATIONS

A3.5

SCALE: 1/8"=1'-0"  
DATE: 05.22.2017  
REVISED DATE: 01.02.2019  
PROJECT: 335005.00

# EXHIBIT H.7 - BUILDING C REAR/RIGHT ELEVATIONS



BUILDING C REAR ELEVATION

BUILDING C - BROADMOOR VILLAGE



BUILDING C RIGHT ELEVATION

BUILDING C - BROADMOOR VILLAGE

BROADMOOR VILLAGE

311 MACARTHUR BLVD.  
SAN LEANDRO, CA



Architecture | Planning | Interiors

444 Spear Street, Suite 105  
San Francisco, CA 94105  
www.hunthalejones.com

t. 415-512-1300  
f. 415-288-0288

BLDG. C REAR & RIGHT ELEVATIONS

A3.6

SCALE: 1/8"=1'-0"  
DATE: 05.22.2017  
REVISED DATE: 01.02.2019  
PROJECT: 335005.00

# EXHIBIT H.8 - BUILDING D ELEVATIONS



BUILDING D FRONT ELEVATION

BUILDING D - BROADMOOR VILLAGE



BUILDING D LEFT ELEVATION

BUILDING D - BROADMOOR VILLAGE



BUILDING D REAR ELEVATION

BUILDING D - BROADMOOR VILLAGE



BUILDING D RIGHT ELEVATION

BUILDING D - BROADMOOR VILLAGE

## BROADMOOR VILLAGE

311 MACARTHUR BLVD.  
SAN LEANDRO, CA



Architecture | Planning | Interiors

444 Spear Street, Suite 105  
San Francisco, CA 94105  
www.hunthalejones.com

t. 415-512-1300  
f. 415-288-0288

BLDG. D ELEVATIONS

A4.2

SCALE: 1/8" = 1'-0"  
DATE: 05.22.2017  
REVISED DATE: 01.02.2019  
PROJECT: 335005.00

# EXHIBIT H.9 - FRONT ELEVATIONS, COLOR



LOT 9 SCHEME A    LOT 8 SCHEME C    LOT 7 SCHEME A    LOT 6 SCHEME B    LOT 5 SCHEME B    LOT 4 SCHEME C    LOT 3 SCHEME B    LOT 2 SCHEME B    LOT 1 SCHEME A

**BUILDING A FRONT ELEVATION**

BROADMOOR VILLAGE



LOT 14 SCHEME A    LOT 13 SCHEME B    LOT 12 SCHEME B    LOT 11 SCHEME C    LOT 10 SCHEME A

**BUILDING B FRONT ELEVATION**

BROADMOOR VILLAGE



LOT 18 SCHEME B    LOT 17 SCHEME B    LOT 16 SCHEME C    LOT 15 SCHEME A

**BUILDING C FRONT ELEVATION**

BROADMOOR VILLAGE



LOT 20 SCHEME B    LOT 19 SCHEME B

**BUILDING D FRONT ELEVATION**

BROADMOOR VILLAGE

## BROADMOOR VILLAGE

311 MACARTHUR BLVD.  
SAN LEANDRO, CA



Architecture | Planning | Interiors

444 Spear Street, Suite 105  
San Francisco, CA 94105  
www.hunthalejones.com

t. 415-512-1300  
f. 415-288-0288

COLOR RENDERING

**A0.4**

SCALE: N.T.S.  
DATE: 05.22.2017  
REVISED DATE: 01.02.2019  
PROJECT: 335005.00



# EXHIBIT H.10 - STREETScape

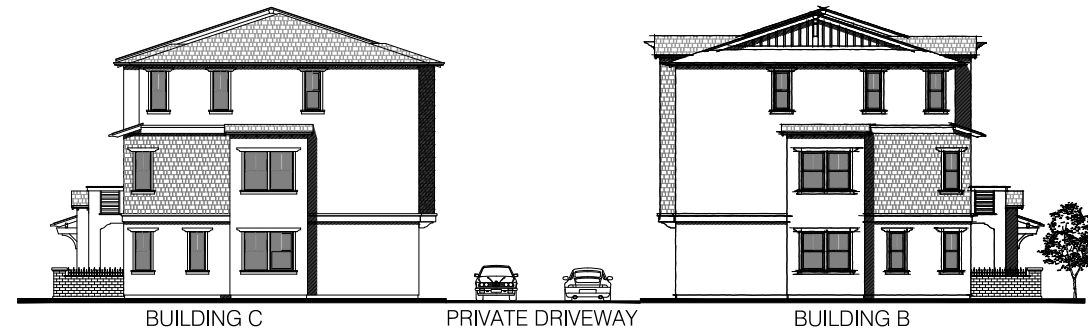

STREETSCAPE TOWARDS BROADMOOR



STREETSCAPE AT MACARTHUR BLVD.

## BROADMOOR VILLAGE

311 MACARTHUR BLVD.  
SAN LEANDRO, CA



Architecture | Planning | Interiors

444 Spear Street, Suite 105  
San Francisco, CA 94105  
www.hunthalejones.com

t. 415-512-1300  
f. 415-288-0288

STREETSCAPE

A0.3

SCALE: 1/128" = 1'-0"  
DATE: 05.22.2017  
REVISED DATE: 01.02.2019  
PROJECT: 335005.00

# EXHIBIT I.1 - BUILDING A GROUND FLOOR

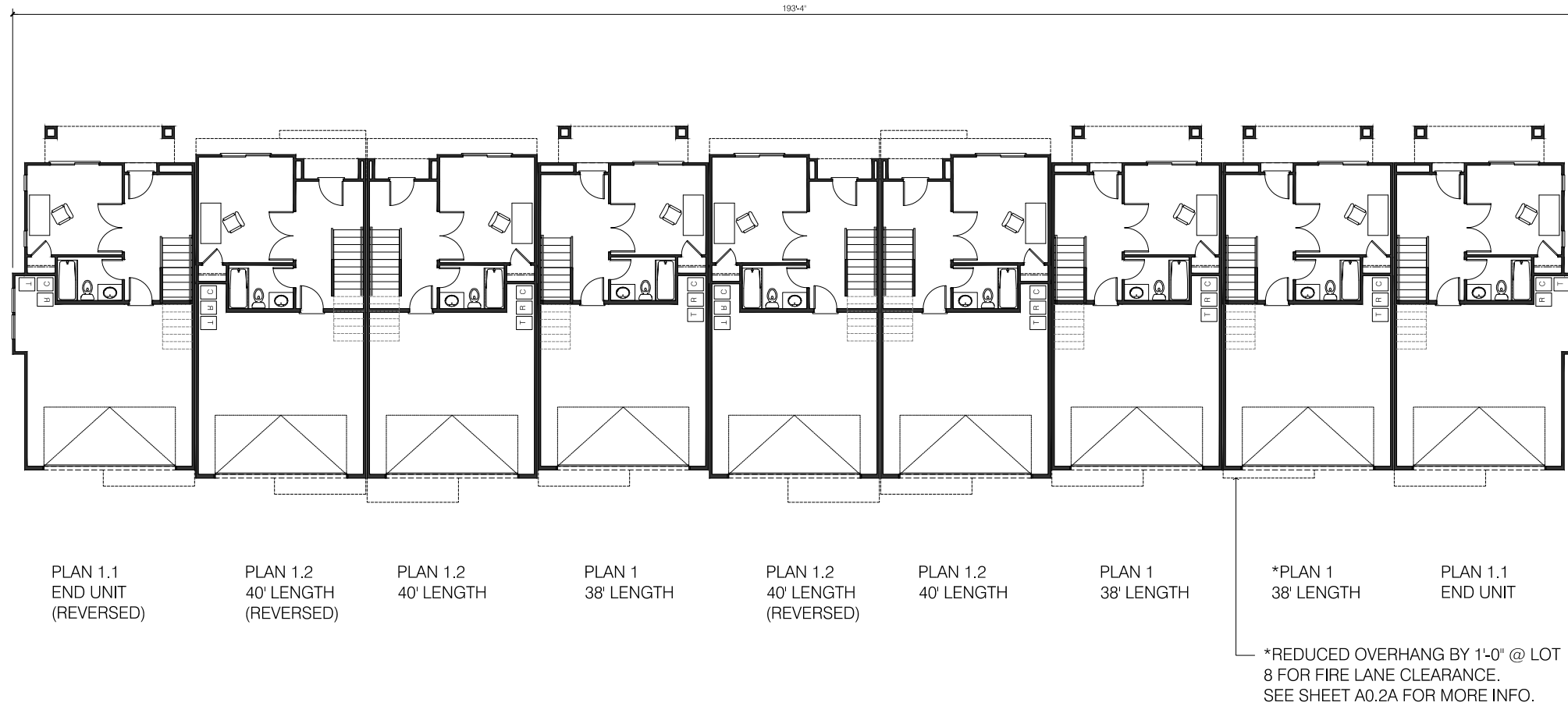

## BUILDING A GROUND FLOOR PLAN

BUILDING A - BROADMOOR VILLAGE

### BROADMOOR VILLAGE

311 MACARTHUR BLVD.  
SAN LEANDRO, CA



Architecture | Planning | Interiors

444 Spear Street, Suite 105  
San Francisco, CA 94105  
www.hunthalejones.com

t. 415-512-1300  
f. 415-288-0288

BLDG. A GROUND FLOOR PLAN

## A1.1

SCALE: 1/8"=1'-0"  
DATE: 05.22.2017  
REVISED DATE: 01.02.2019  
PROJECT: 335005.00

# EXHIBIT I.2 - BUILDING A MAIN FLOOR

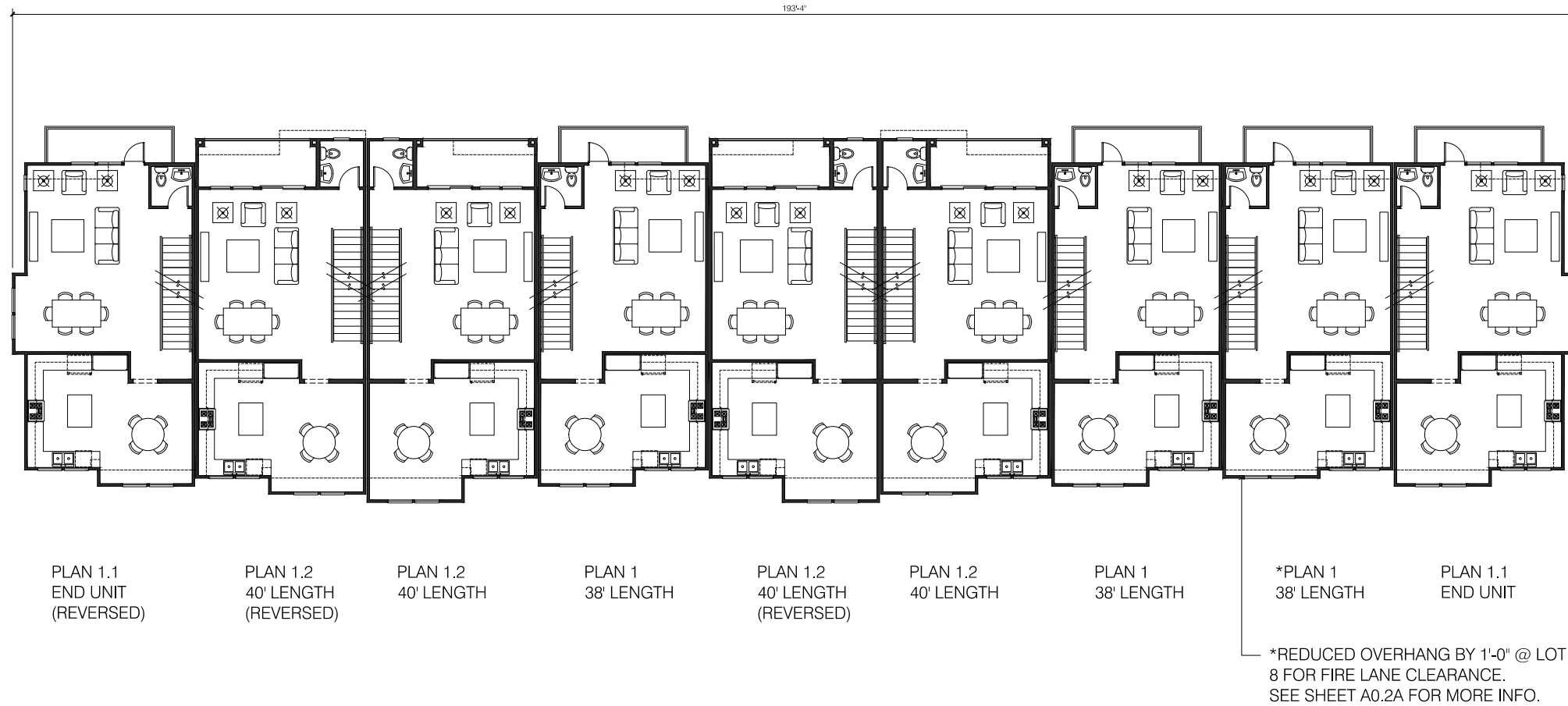

## BUILDING A MAIN FLOOR PLAN

BUILDING A - BROADMOOR VILLAGE

### BROADMOOR VILLAGE

311 MACARTHUR BLVD.  
SAN LEANDRO, CA



Architecture | Planning | Interiors

444 Spear Street, Suite 105  
San Francisco, CA 94105  
www.hunthalejones.com

t. 415-512-1300  
f. 415-288-0288

BLDG. A MAIN FLOOR PLAN

## A1.2

SCALE: 1/8"=1'-0"  
DATE: 05.22.2017  
REVISED DATE: 01.02.2019  
PROJECT: 335005.00

# EXHIBIT I.3 - BUILDING A UPPER FLOOR

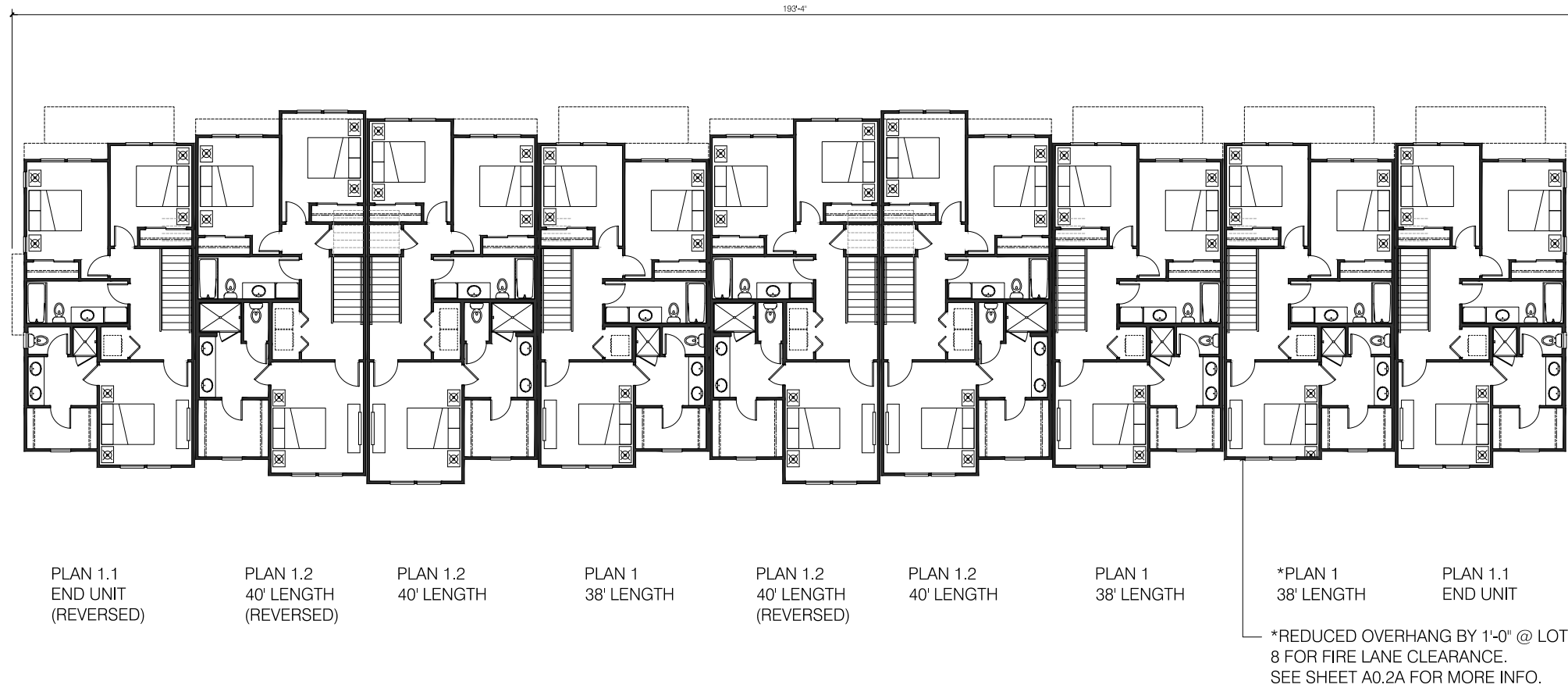

## BUILDING A UPPER FLOOR PLAN

BUILDING A - BROADMOOR VILLAGE

### BROADMOOR VILLAGE

311 MACARTHUR BLVD.  
SAN LEANDRO, CA



Architecture | Planning | Interiors

444 Spear Street, Suite 105  
San Francisco, CA 94105  
www.hunthalejones.com

t. 415-512-1300  
f. 415-288-0288

BLDG. A UPPER FLOOR PLAN

## A1.3

SCALE: 1/8"=1'-0"  
DATE: 05.22.2017  
REVISED DATE: 01.02.2019  
PROJECT: 335005.00

# EXHIBIT I.4 - BUILDING B GROUND FLOOR

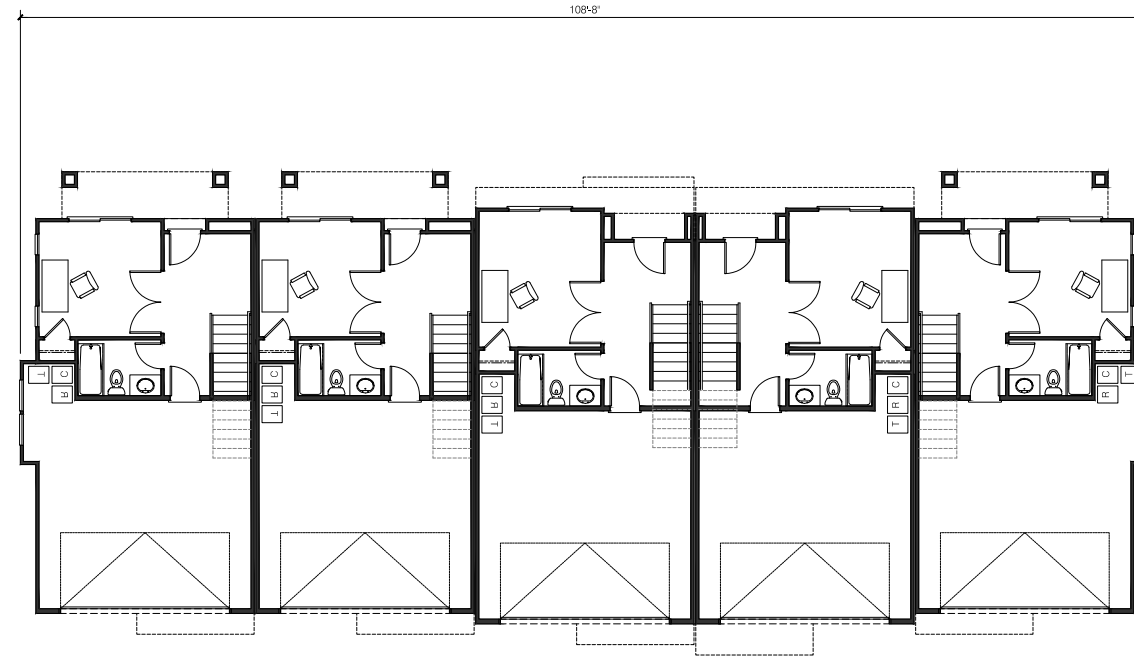

PLAN 1.1  
END UNIT  
(REVERSED)

PLAN 1  
38' LENGTH  
(REVERSED)

PLAN 1.2  
40' LENGTH  
(REVERSED)

PLAN 1.2  
40' LENGTH

PLAN 1.1  
END UNIT

## BUILDING B GROUND FLOOR PLAN

BUILDING B - BROADMOOR VILLAGE

### BROADMOOR VILLAGE

311 MACARTHUR BLVD.  
SAN LEANDRO, CA



Architecture | Planning | Interiors

444 Spear Street, Suite 105  
San Francisco, CA 94105  
www.hunthalejones.com

t. 415-512-1300  
f. 415-288-0288

BLDG. B GROUND FLOOR PLAN

A2.1

SCALE: 1/8"=1'-0"  
DATE: 05.22.2017  
REVISED DATE: 01.02.2019  
PROJECT: 335005.00

# EXHIBIT I.5 - BUILDIGN B MAIN FLOOR

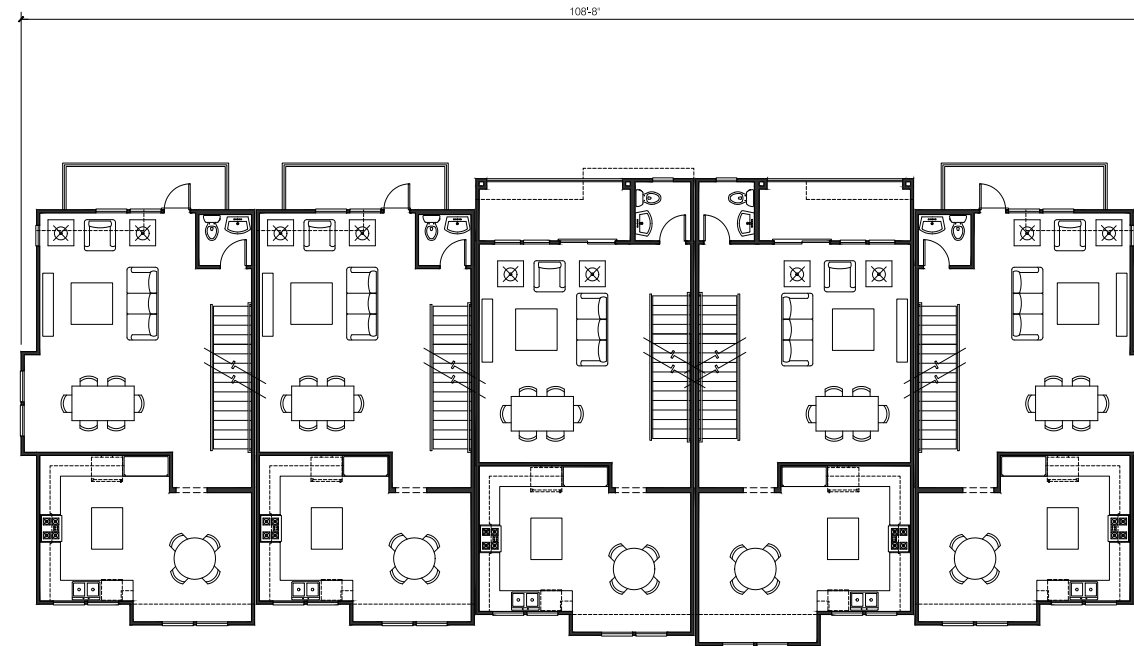

PLAN 1.1  
END UNIT  
(REVERSED)

PLAN 1  
38' LENGTH  
(REVERSED)

PLAN 1.2  
40' LENGTH  
(REVERSED)

PLAN 1.2  
40' LENGTH

PLAN 1.1  
END UNIT  
(REVERSED)

## BUILDING B MAIN FLOOR PLAN

BUILDING B - BROADMOOR VILLAGE

### BROADMOOR VILLAGE

311 MACARTHUR BLVD.  
SAN LEANDRO, CA



Architecture | Planning | Interiors

444 Spear Street, Suite 105  
San Francisco, CA 94105  
www.hunthalejones.com

t. 415-512-1300  
f. 415-288-0288

BLDG. B MAIN FLOOR PLAN

A2.2

SCALE: 1/8"=1'-0"  
DATE: 05.22.2017  
REVISED DATE: 01.02.2019  
PROJECT: 335005.00

# EXHIBIT I.6 - BUILDING B UPPER FLOOR

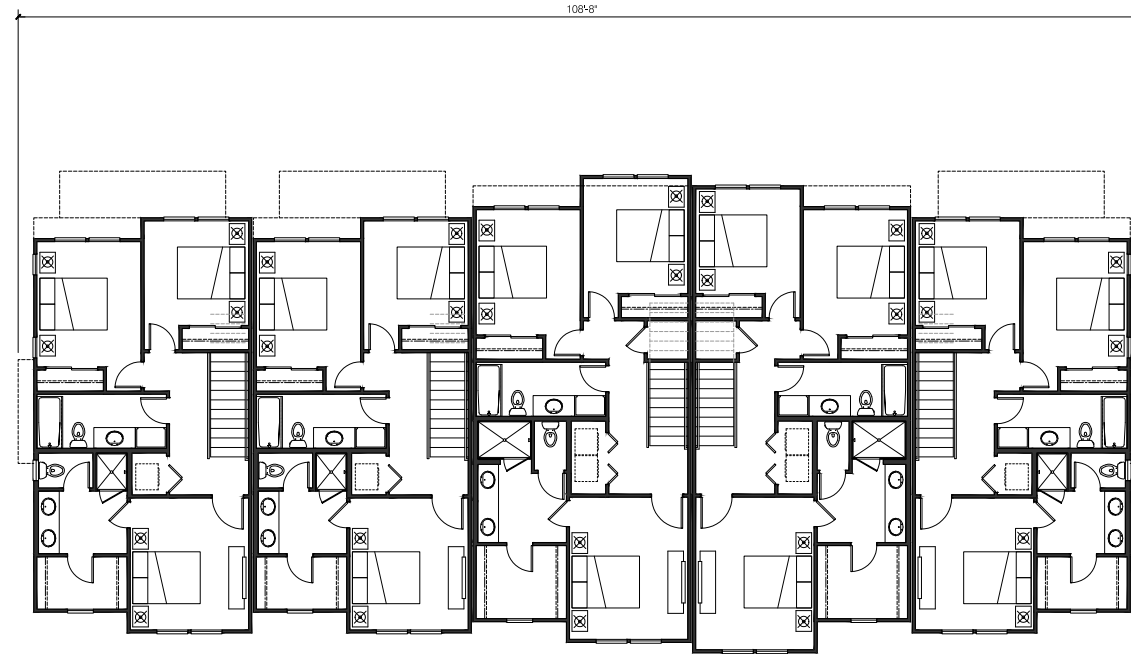

PLAN 1.1  
END UNIT  
(REVERSED)

PLAN 1  
38' LENGTH  
(REVERSED)

PLAN 1.2  
40' LENGTH  
(REVERSED)

PLAN 1.2  
40' LENGTH

PLAN 1.1  
END UNIT

## BUILDING B UPPER FLOOR PLAN

BUILDING B - BROADMOOR VILLAGE

### BROADMOOR VILLAGE

311 MACARTHUR BLVD.  
SAN LEANDRO, CA



Architecture | Planning | Interiors

444 Spear Street, Suite 105  
San Francisco, CA 94105  
www.hunthalejones.com

t. 415-512-1300  
f. 415-288-0288

BLDG. B UPPER FLOOR PLAN

## A2.3

SCALE: 1/8"=1'-0"  
DATE: 05.22.2017  
REVISED DATE: 01.02.2019  
PROJECT: 335005.00

# EXHIBIT I.7 - BUILDING C GROUND FLOOR

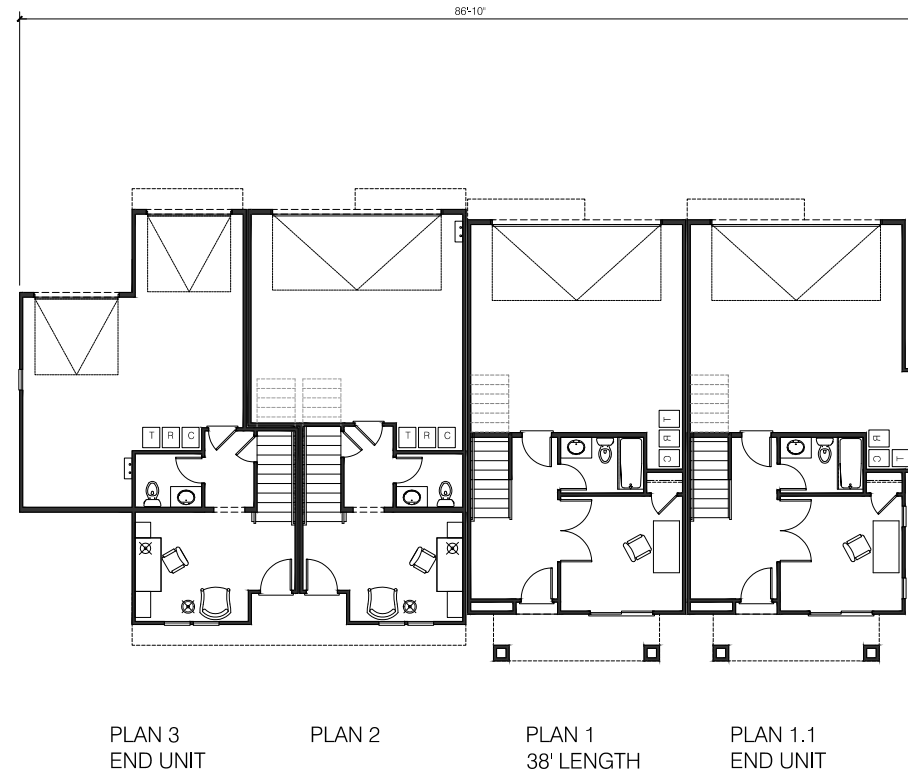

BUILDING C GROUND FLOOR PLAN

BUILDING C - BROADMOOR VILLAGE

BROADMOOR VILLAGE

311 MACARTHUR BLVD.

SAN LEANDRO, CA



Architecture | Planning | Interiors

444 Spear Street, Suite 105  
San Francisco, CA 94105  
www.hunthalejones.com

t. 415-512-1300  
f. 415-288-0288

BLDG. C GROUND FLOOR PLAN

A3.1

SCALE: 1/8"=1'-0"  
DATE: 05.22.2017  
REVISED DATE: 01.02.2019  
PROJECT: 335005.00



# EXHIBIT I.8 - BUILDING C MAIN FLOOR

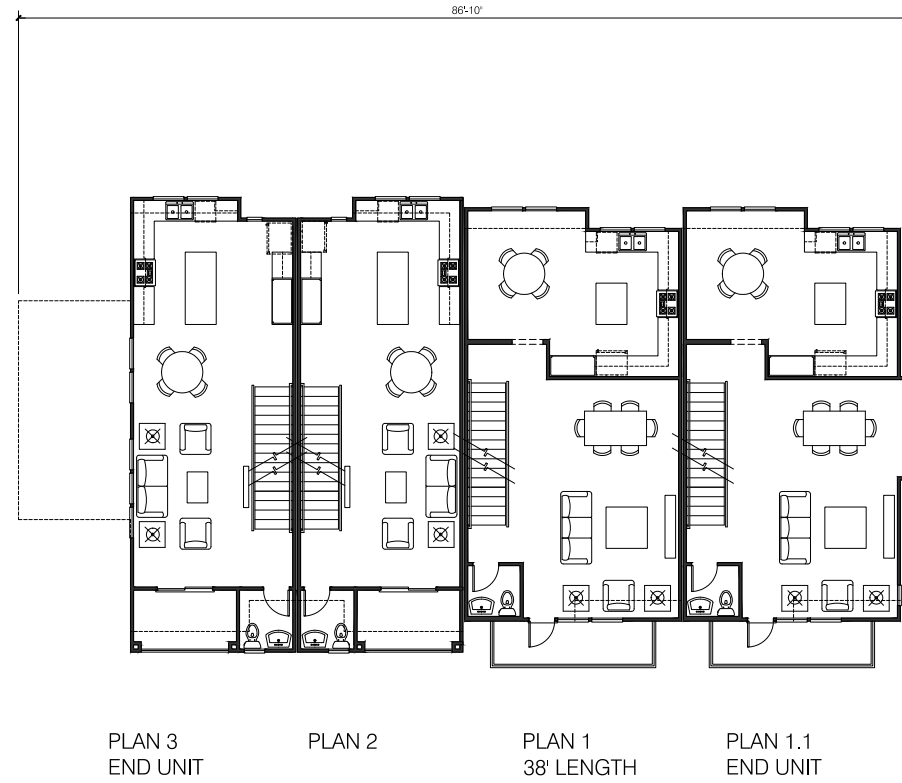

BUILDING C MAIN FLOOR PLAN

BUILDING C - BROADMOOR VILLAGE

BROADMOOR VILLAGE

311 MACARTHUR BLVD.  
SAN LEANDRO, CA



Architecture | Planning | Interiors

444 Spear Street, Suite 105  
San Francisco, CA 94105  
www.hunthalejones.com

t. 415-512-1300  
f. 415-288-0288

BLDG. C MAIN FLOOR PLAN

A3.2

SCALE: 1/8"=1'-0"  
DATE: 05.22.2017  
REVISED DATE: 01.02.2019  
PROJECT: 335005.00

# EXHIBIT I.9 - BUILDING C UPPER FLOOR

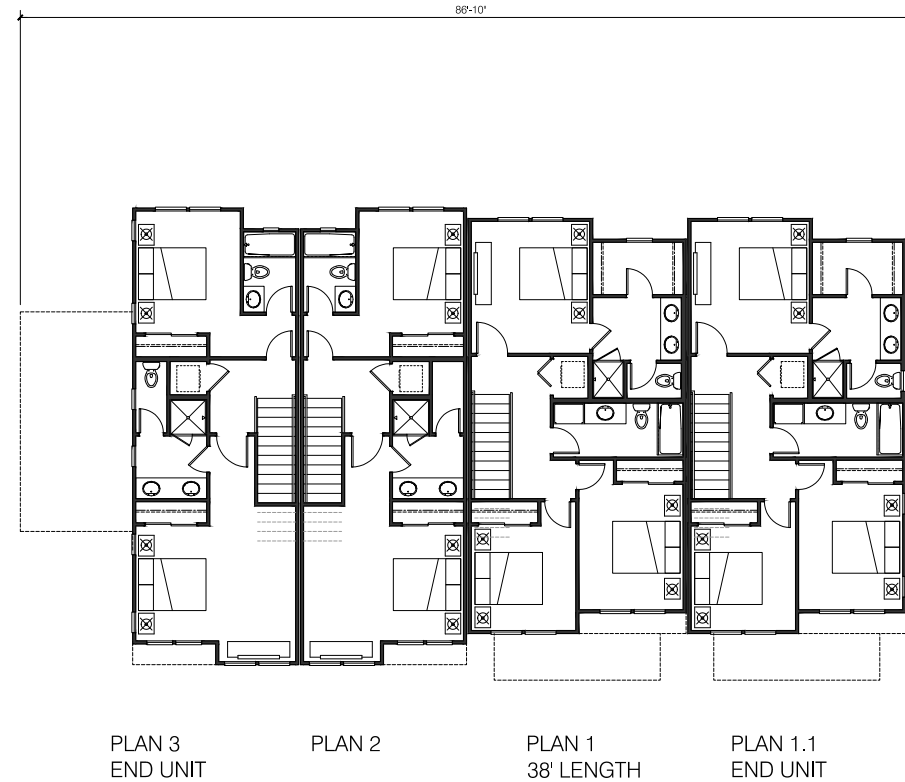

BUILDING C UPPER FLOOR PLAN

BUILDING C - BROADMOOR VILLAGE

## BROADMOOR VILLAGE

311 MACARTHUR BLVD.  
SAN LEANDRO, CA



Architecture | Planning | Interiors

444 Spear Street, Suite 105  
San Francisco, CA 94105  
www.hunthalejones.com

t. 415-512-1300  
f. 415-288-0288

BLDG. C UPPER FLOOR PLAN

A3.3

SCALE: 1/8"=1'-0"  
DATE: 05.22.2017  
REVISED DATE: 01.02.2019  
PROJECT: 335005.00

# EXHIBIT I.10 - BUILDING D FLOOR PLANS AND ROOF PLAN

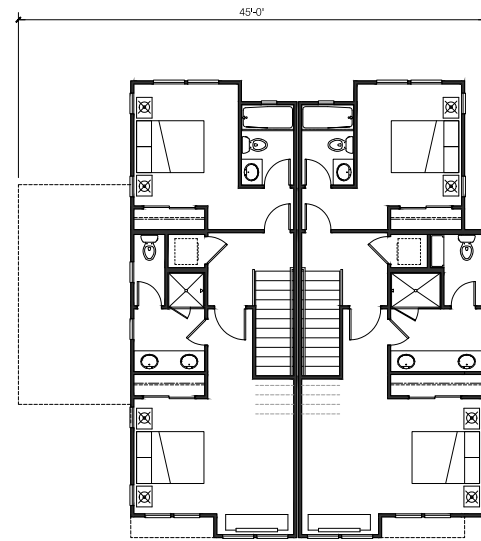

PLAN 3  
END UNIT      PLAN 2  
END UNIT

BUILDING D UPPER FLOOR PLAN

BUILDING D - BROADMOOR VILLAGE

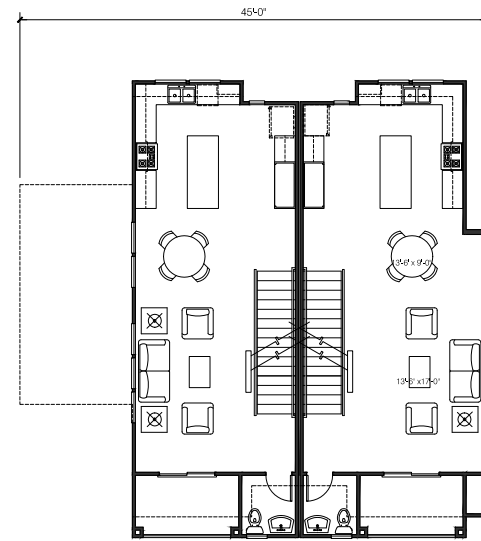

PLAN 3  
END UNIT      PLAN 2  
END UNIT

BUILDING D MAIN FLOOR PLAN

BUILDING D - BROADMOOR VILLAGE

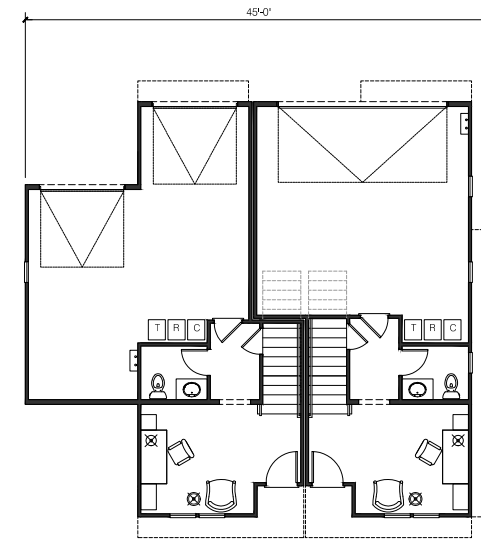

PLAN 3  
END UNIT      PLAN 2  
END UNIT

BUILDING D GROUND FLOOR PLAN

BUILDING D - BROADMOOR VILLAGE

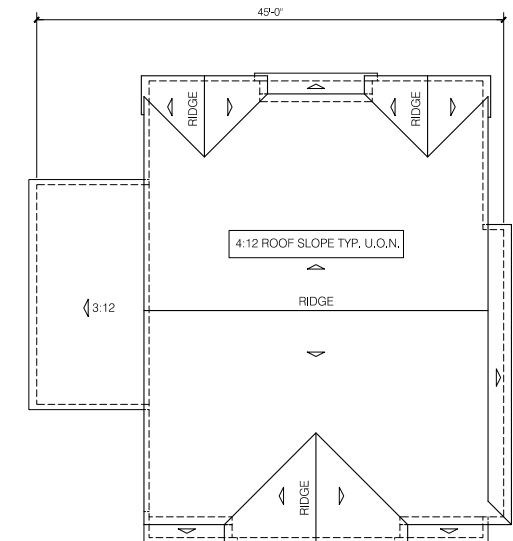

BUILDING D ROOF PLAN

BUILDING D - BROADMOOR VILLAGE

## BROADMOOR VILLAGE

311 MACARTHUR BLVD.  
SAN LEANDRO, CA



Architecture | Planning | Interiors

444 Spear Street, Suite 105  
San Francisco, CA 94105  
www.hunthalejones.com

t. 415-512-1300  
f. 415-288-0288

BLDG. D FLOOR PLANS & ROOF PLAN

A4.1

SCALE: 1/8" = 1'-0"  
DATE: 05.22.2017  
REVISED DATE: 01.02.2019  
PROJECT: 335005.00

# EXHIBIT J.1 - PLAN 1 ALL FLOORS

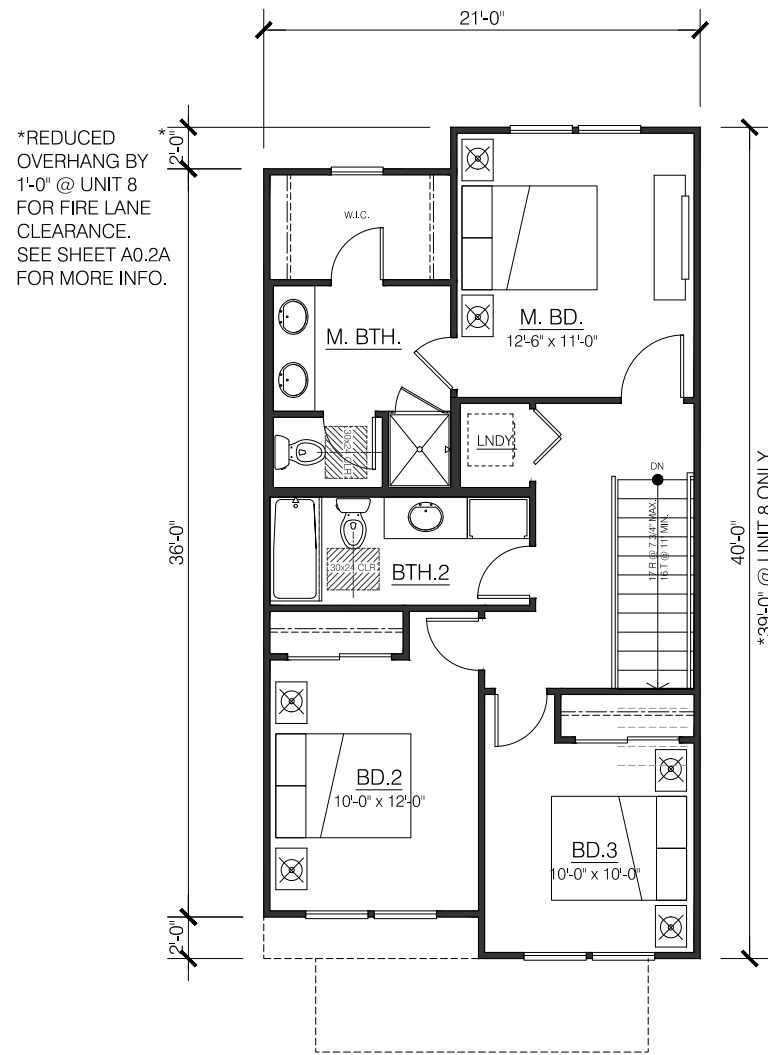

UPPER FLOOR

PLAN 1

UPPER LIVING: 761 SQ. FT.

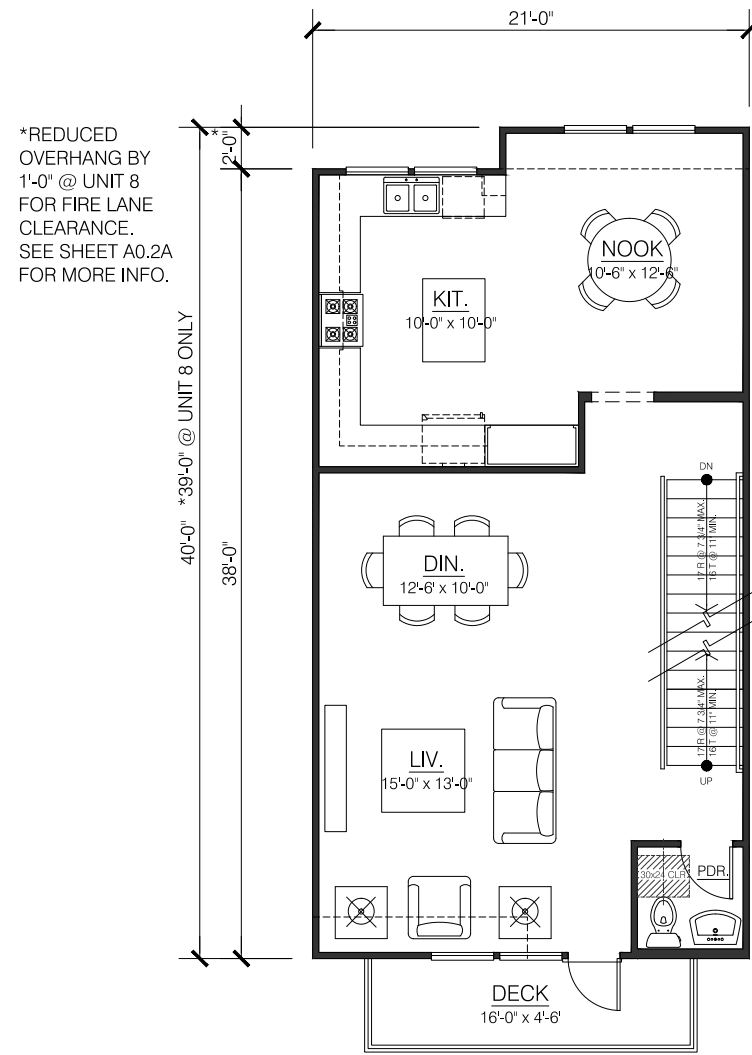

MAIN FLOOR

PLAN 1

MAIN LIVING: 822 SQ. FT.  
TOTAL LIVING: 1893 SQ. FT.

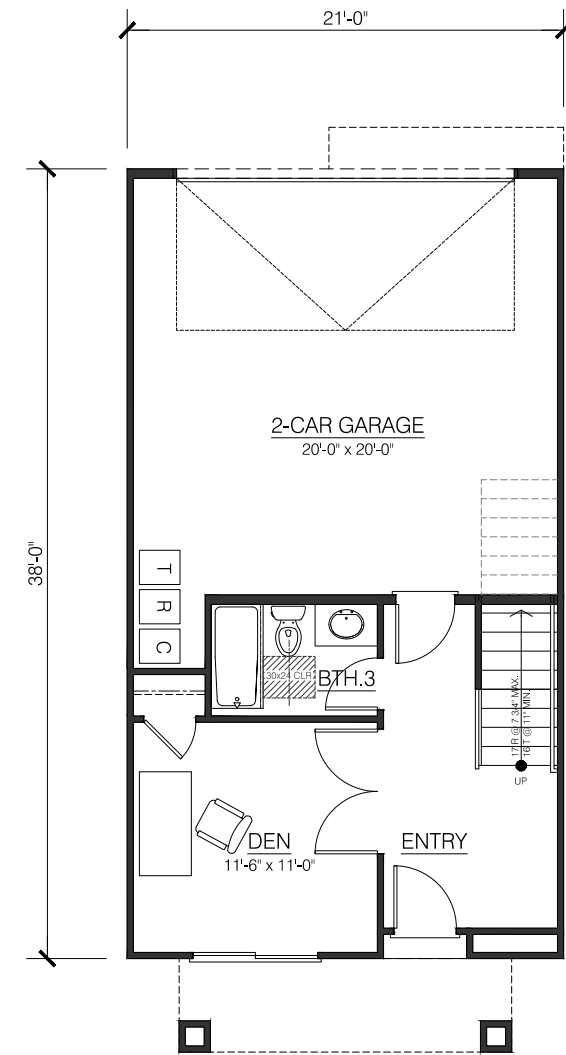

GROUND FLOOR

PLAN 1

GROUND LIVING: 310 SQ. FT.  
GARAGE: 453 SQ. FT.

BROADMOOR VILLAGE

311 MACARTHUR BLVD.

SAN LEANDRO, CA



Architecture | Planning | Interiors

444 Spear Street, Suite 105  
San Francisco, CA 94105  
www.hunthalejones.com

t. 415-512-1300  
f. 415-288-0288

PLAN 1

A5.1

SCALE: 1/4"=1'-0"  
DATE: 05.22.2017  
REVISED DATE: 01.02.2019  
PROJECT: 335005.00

# EXHIBIT J.2 - PLAN 1.1 ALL FLOORS

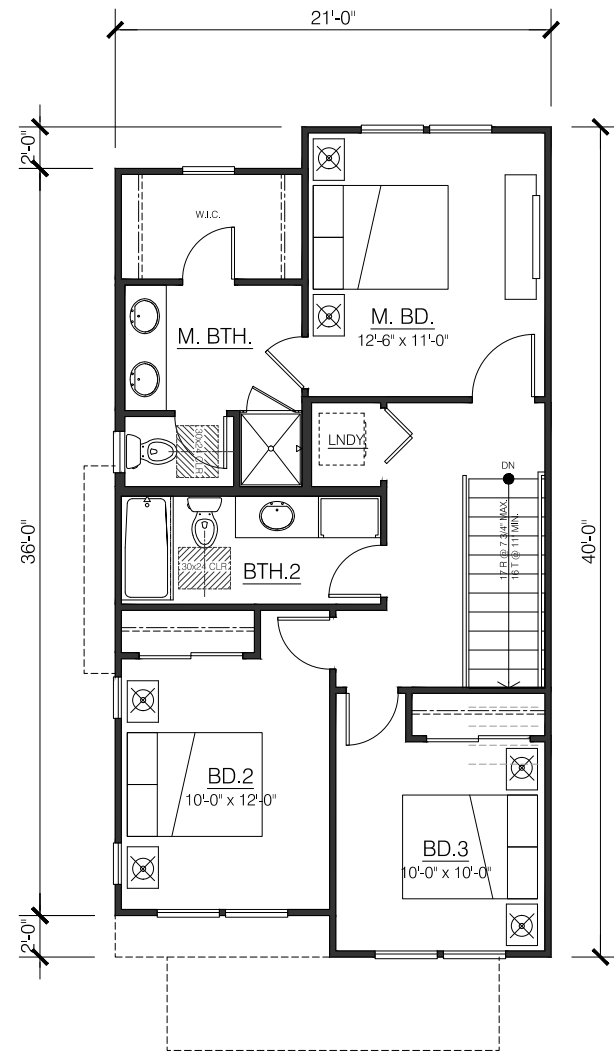

UPPER FLOOR

PLAN 1.1  
END UNIT

UPPER LIVING: 761 SQ. FT.

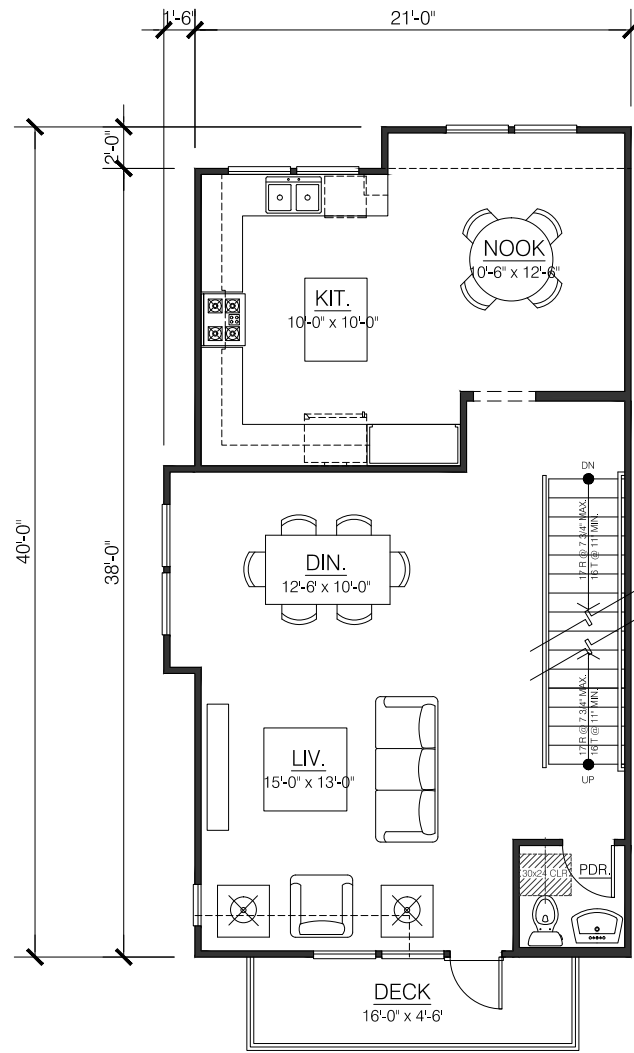

MAIN FLOOR

PLAN 1.1  
END UNIT

MAIN LIVING: 837 SQ. FT.  
TOTAL LIVING: 1908 SQ. FT.

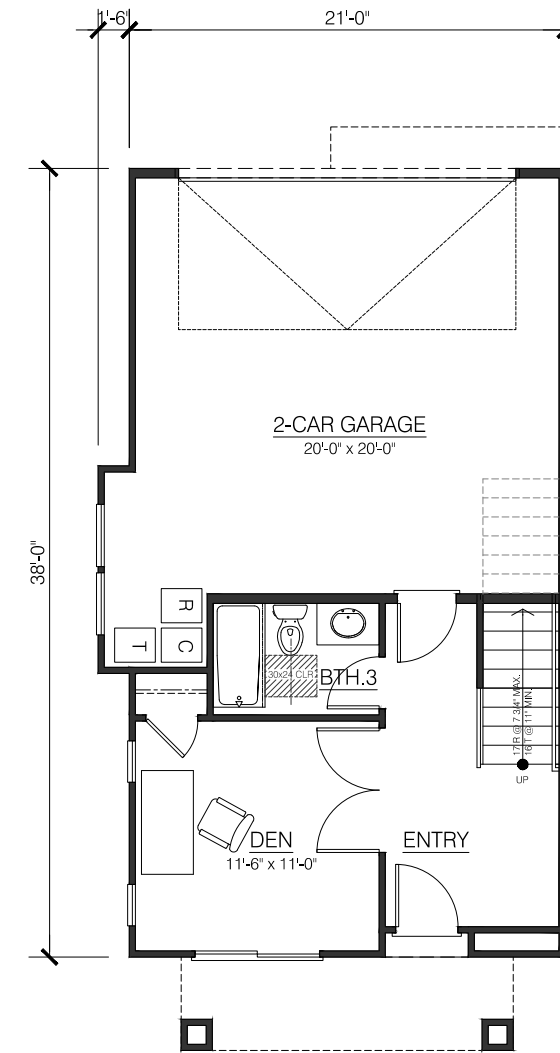

GROUND FLOOR

PLAN 1.1  
END UNIT

GROUND LIVING: 310 SQ. FT.  
GARAGE: 468 SQ. FT.

BROADMOOR VILLAGE

311 MACARTHUR BLVD.  
SAN LEANDRO, CA



Architecture | Planning | Interiors

444 Spear Street, Suite 105  
San Francisco, CA 94105  
www.hunthalejones.com

t. 415-512-1300  
f. 415-288-0288

PLAN 1.1

A5.2

SCALE: 1/4"=1'-0"  
DATE: 05.22.2017  
REVISED DATE: 01.02.2019  
PROJECT: 335005.00

# EXHIBIT J.3 - PLAN 1.2 GROUND AND MAIN FLOOR

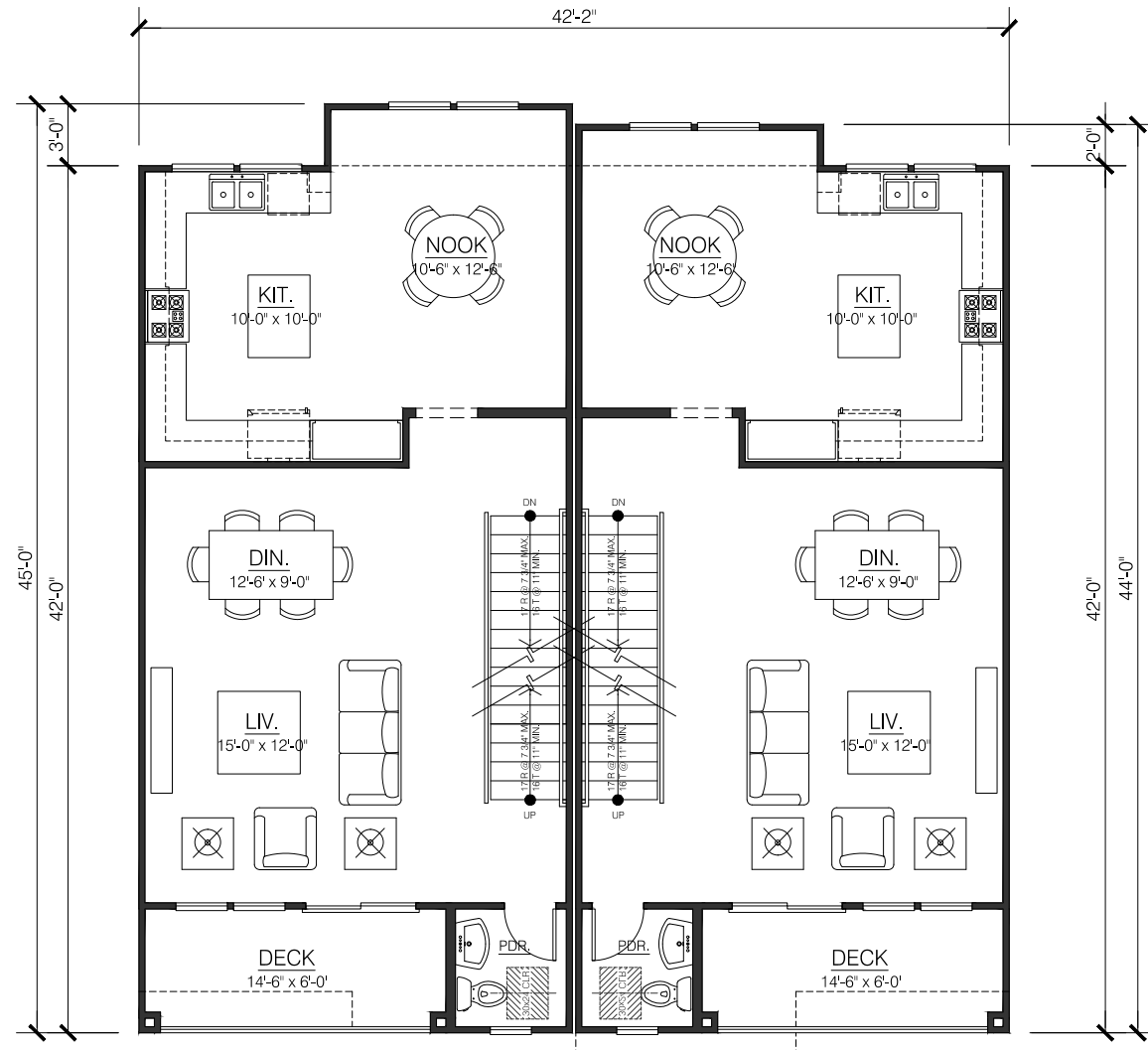

MAIN FLOOR

PLAN 1.2  
40' LENGTH

MAIN LIVING: 829 SQ. FT.  
TOTAL LIVING: 2017 SQ. FT.

PLAN 1.2 R  
40' LENGTH

MAIN LIVING: 817 SQ. FT.  
TOTAL LIVING: 2004 SQ. FT.

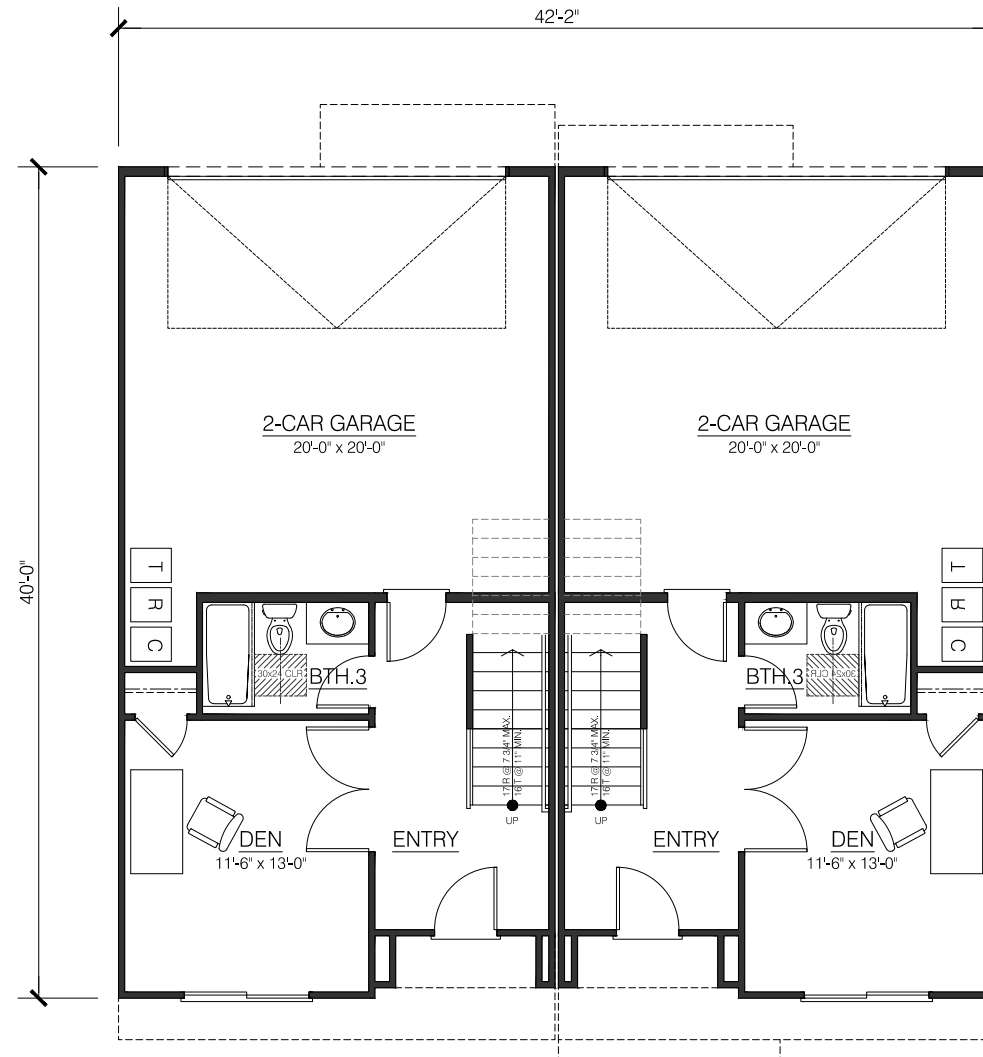

GROUND FLOOR

PLAN 1.2  
40' LENGTH

GROUND LIVING: 323 SQ. FT.  
GARAGE: 453 SQ. FT.

PLAN 1.2 R  
40' LENGTH

GROUND LIVING: 323 SQ. FT.  
GARAGE: 453 SQ. FT.

## BROADMOOR VILLAGE

311 MACARTHUR BLVD.  
SAN LEANDRO, CA



Architecture | Planning | Interiors

444 Spear Street, Suite 105  
San Francisco, CA 94105  
www.hunthalejones.com

t. 415-512-1300  
f. 415-288-0288

PLAN 1.2

A5.3

SCALE: 1/4"=1'-0"  
DATE: 05.22.2017  
REVISED DATE: 01.02.2019  
PROJECT: 335005.00

# EXHIBIT J.4 - PLAN 1.2 UPPER FLOOR

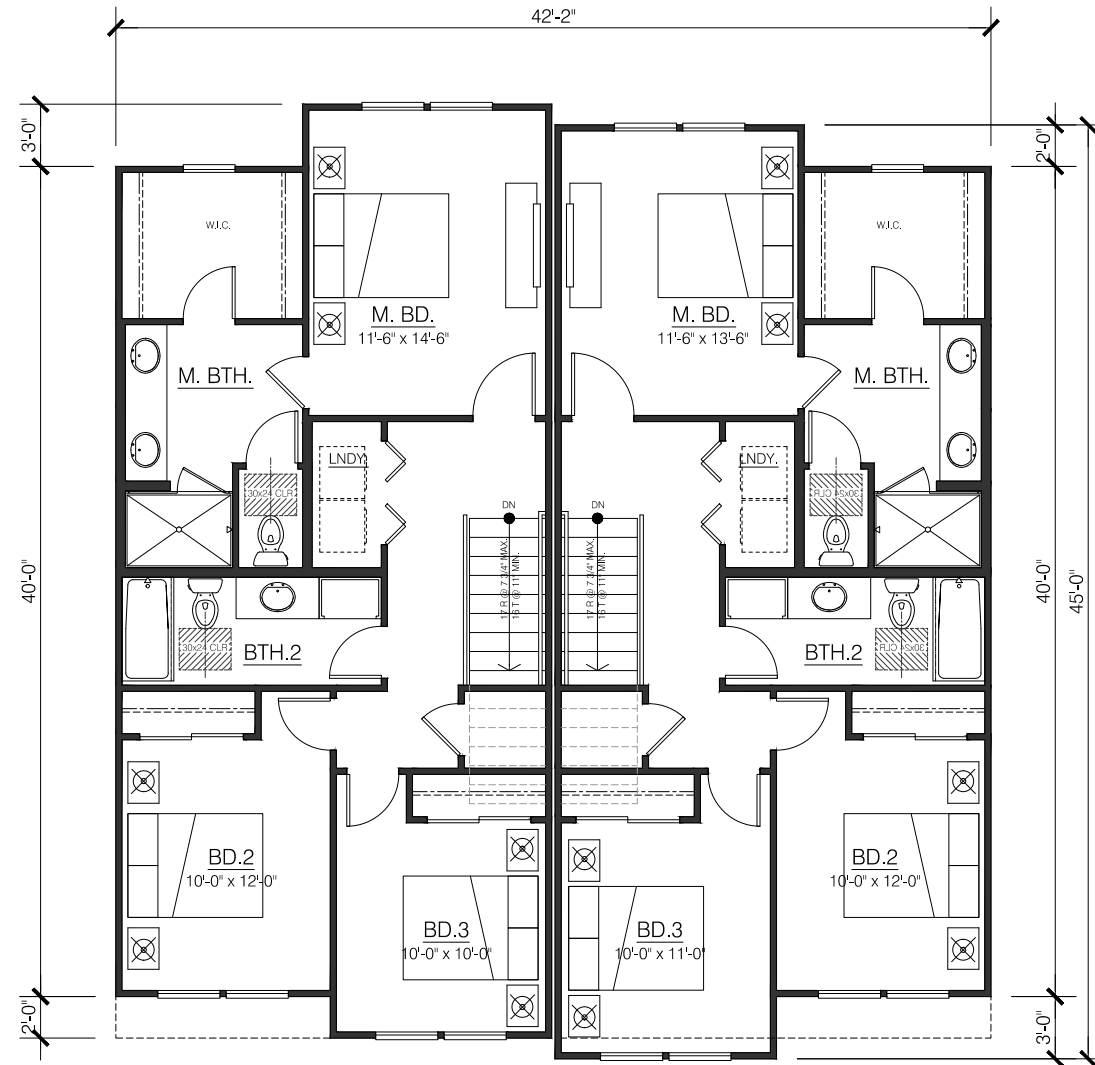

UPPER FLOOR

PLAN 1.2  
40' LENGTH  
UPPER LIVING: 866 SQ. FT.

PLAN 1.2 R  
40' LENGTH  
UPPER LIVING: 864 SQ. FT.

## BROADMOOR VILLAGE

311 MACARTHUR BLVD.  
SAN LEANDRO, CA



Architecture | Planning | Interiors

444 Spear Street, Suite 105  
San Francisco, CA 94105  
www.hunthalejones.com

t. 415-512-1300  
f. 415-288-0288

PLAN 1.2

A5.4

SCALE: 1/4"=1'-0"  
DATE: 05.22.2017  
REVISED DATE: 01.02.2019  
PROJECT: 335005.00

# EXHIBIT J.5 - PLANS 2 AND 3 GROUND AND MAIN FLOOR

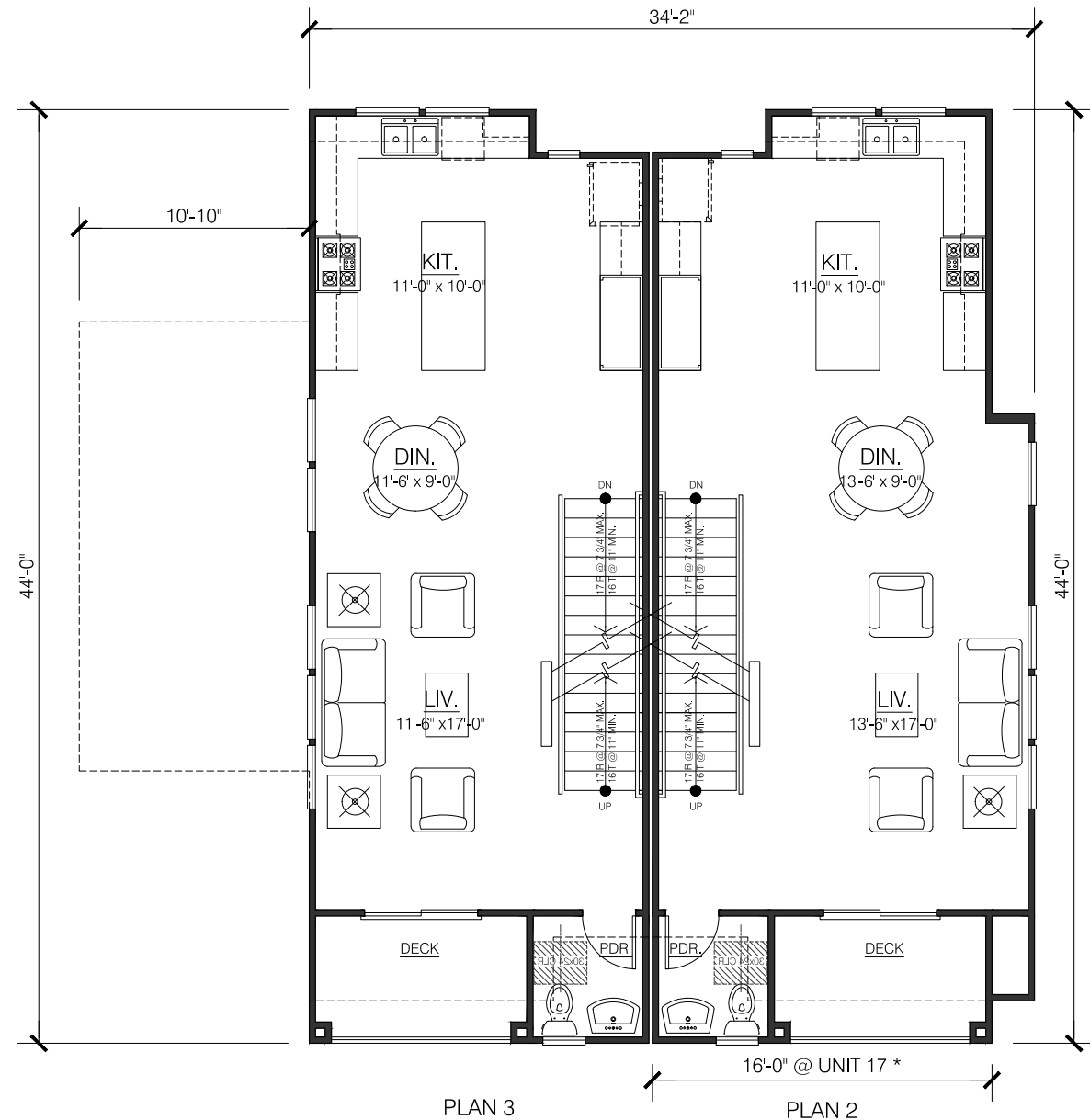

\*UNIT 17 - SPECIAL CONDITION.  
NO WINDOWS AT COMMON WALL WITH UNIT 16.

## MAIN FLOOR

PLAN 2 UNIT 19	MAIN LIVING: 681 SQ. FT. TOTAL LIVING: 1611 SQ. FT.
PLAN 2 UNIT 17	MAIN LIVING: 632 SQ. FT. TOTAL LIVING: 1507 SQ. FT.
PLAN 3	MAIN LIVING: 632 SQ. FT. TOTAL LIVING: 1504 SQ. FT.

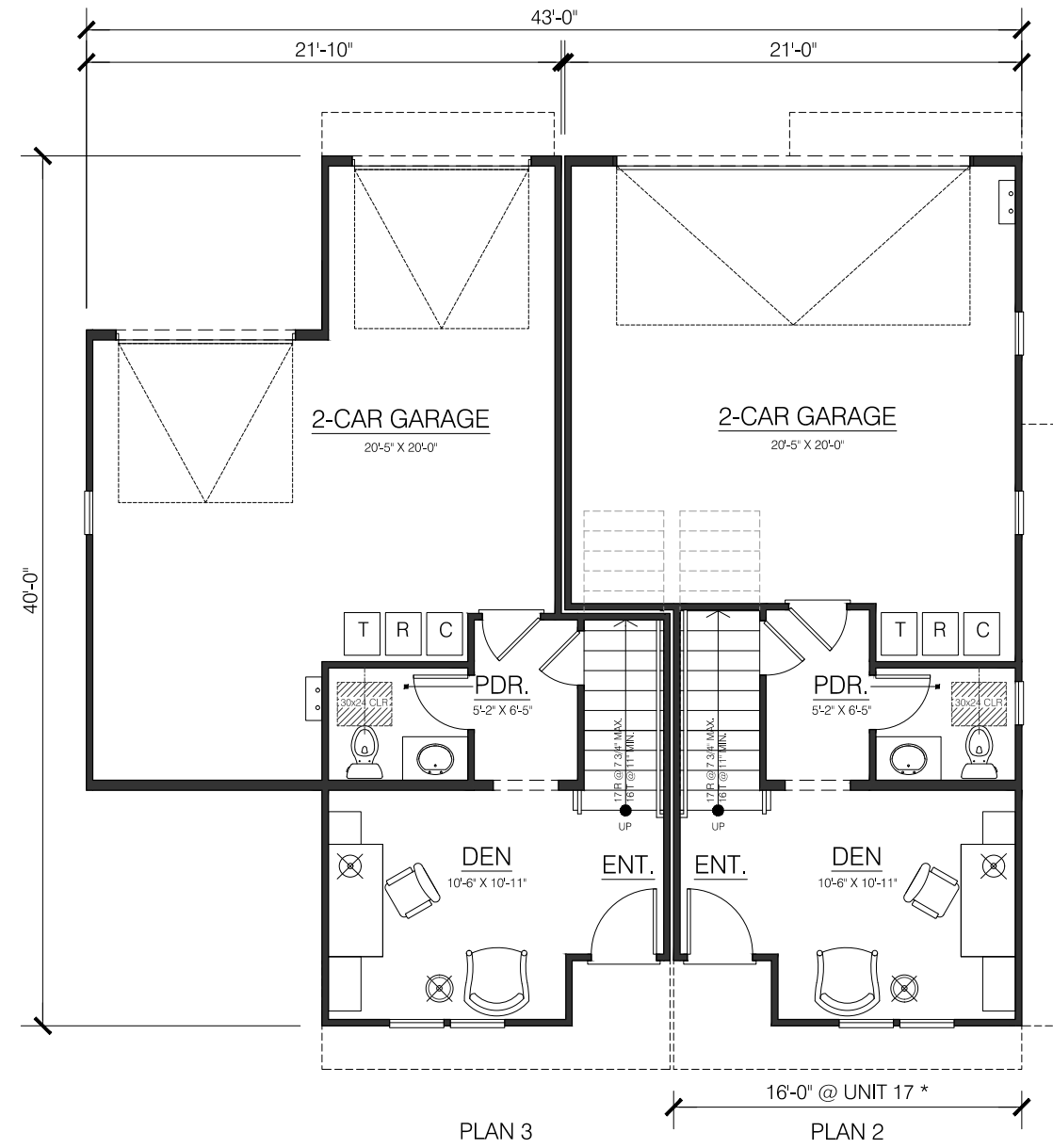

\*UNIT 17 - SPECIAL CONDITION.  
NO WINDOWS AT COMMON WALL WITH UNIT 16.

## GROUND FLOOR

PLAN 2 UNIT 19	GROUND LIVING: 237 SQ. FT. GARAGE: 457 SQ. FT.
PLAN 2 UNIT 17	GROUND LIVING: 237 SQ. FT. GARAGE: 457 SQ. FT.
PLAN 3	GROUND LIVING: 235 SQ. FT. GARAGE: 480 SQ. FT.

## BROADMOOR VILLAGE

311 MACARTHUR BLVD.  
SAN LEANDRO, CA



Architecture | Planning | Interiors

444 Spear Street, Suite 105  
San Francisco, CA 94105  
www.hunthalejones.com

t. 415-512-1300  
f. 415-288-0288

PLAN 2&3

A5.5

SCALE: 1/4"=1'-0"  
DATE: 05.22.2017  
REVISED DATE: 01.02.2019  
PROJECT: 335005.00



# EXHIBIT J.6 - PLANS 2 AND 3 UPPER FLOOR

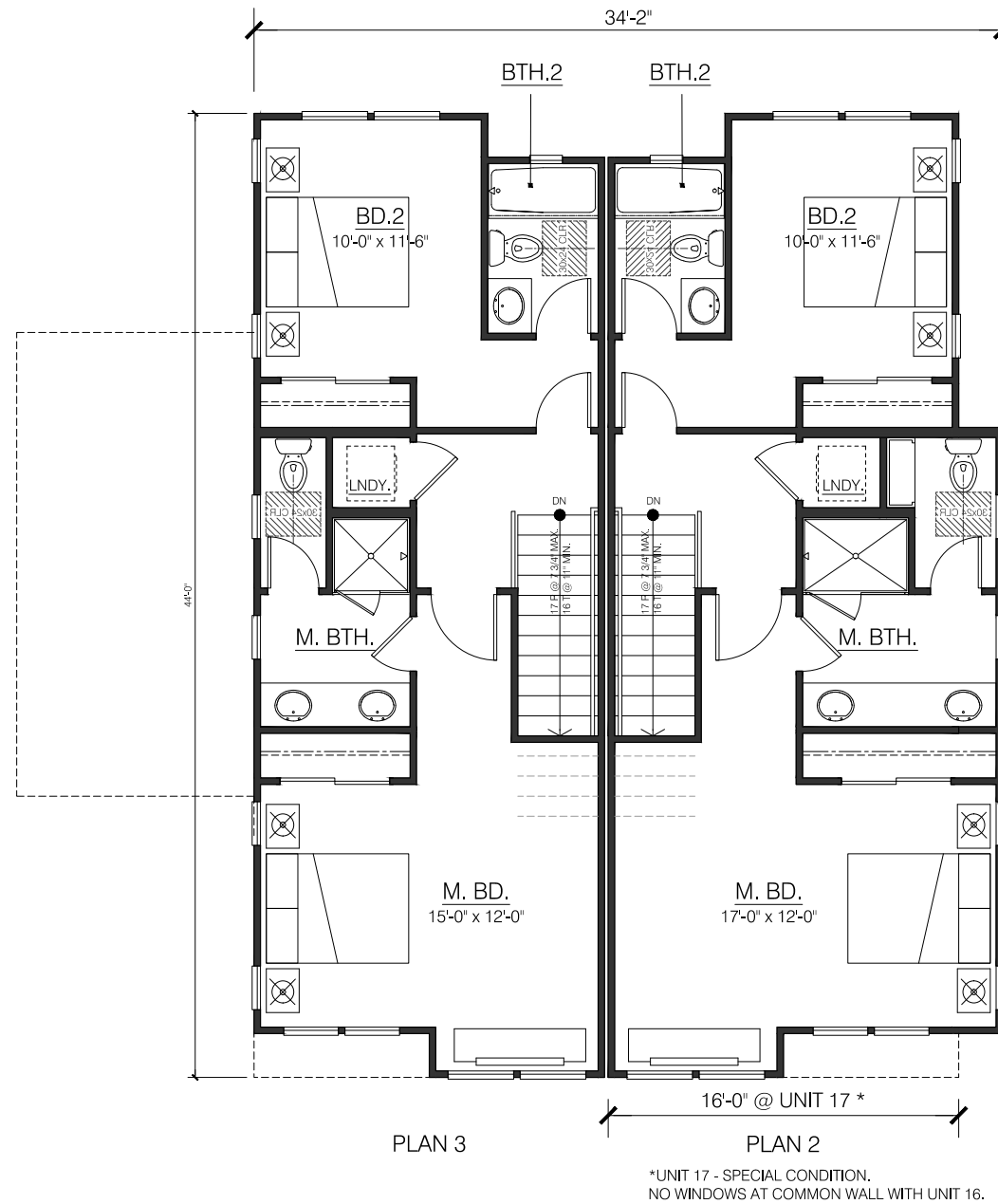

## UPPER FLOOR

PLAN 2 UNIT 19	UPPER LIVING: 693 SQ. FT.
PLAN 2 UNIT 17	UPPER LIVING: 637 SQ. FT.
PLAN 3	UPPER LIVING: 637 SQ. FT.

**BROADMOOR VILLAGE**

311 MACARTHUR BLVD.

PLN17-0034 311 MACARTHUR BOULEVARD - 20-Unit Townhome Condominium Development - Zoning Amendment, Planned Development, Tentative Map, Site Plan Review

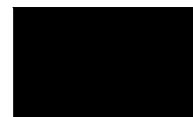

Architecture | Planning | Interiors

444 Spear Street, Suite 105  
San Francisco, CA 94105

PLAN 2&3

A5.6

# EXHIBIT K.1 - BUILDING A ROOF PLAN

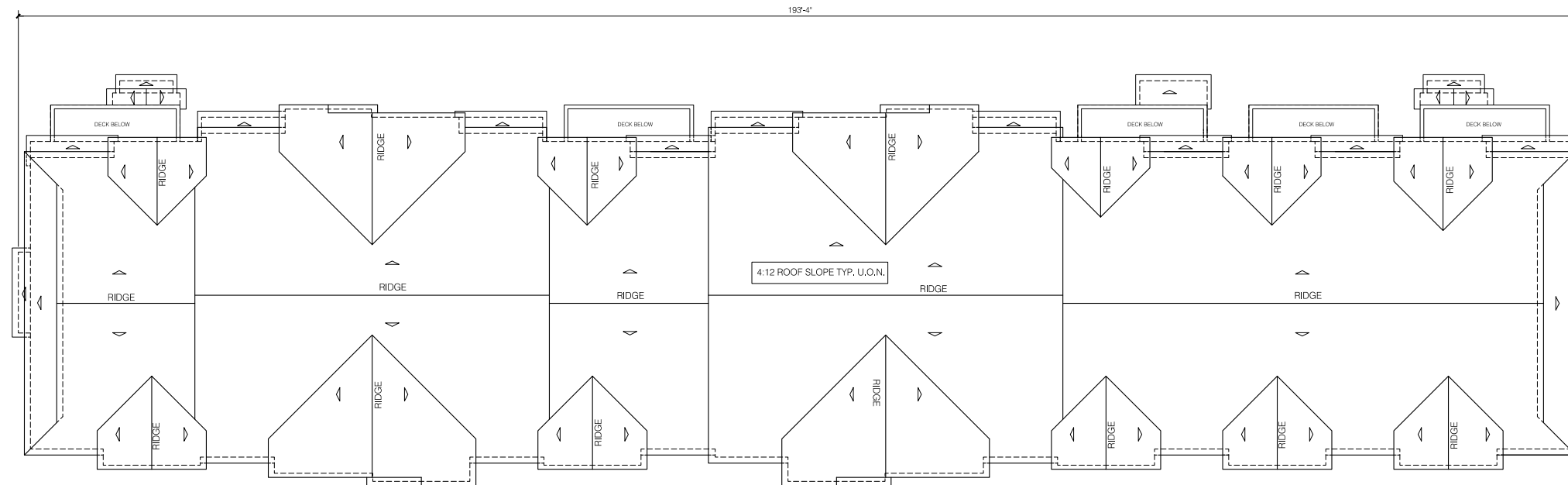

## BUILDING A ROOF PLAN

BUILDING A - BROADMOOR VILLAGE

### BROADMOOR VILLAGE

311 MACARTHUR BLVD.  
SAN LEANDRO, CA



Architecture | Planning | Interiors

444 Spear Street, Suite 105  
San Francisco, CA 94105  
www.hunthalejones.com

t. 415-512-1300  
f. 415-288-0288

BLDG. A ROOF PLAN

## A1.4

SCALE: 1/8"=1'-0"  
DATE: 05.22.2017  
REVISED DATE: 01.02.2019  
PROJECT: 335005.00

# EXHIBIT K.2 - BUILDING B ROOF PLAN

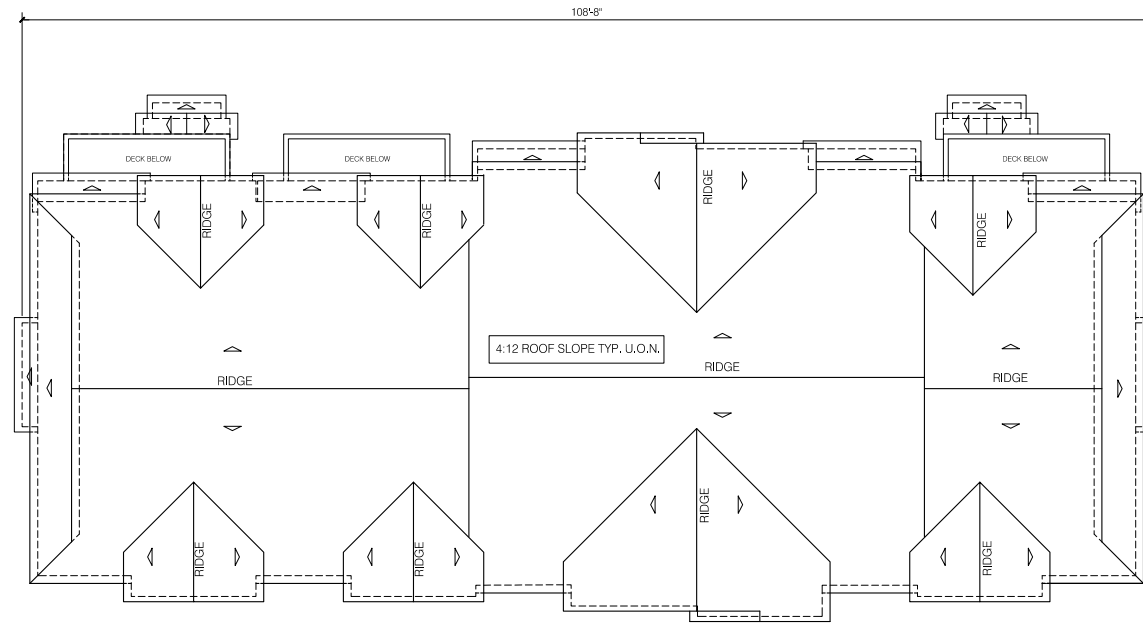

BUILDING B ROOF PLAN

BUILDING B - BROADMOOR VILLAGE

## BROADMOOR VILLAGE

311 MACARTHUR BLVD.  
SAN LEANDRO, CA



Architecture | Planning | Interiors

444 Spear Street, Suite 105  
San Francisco, CA 94105  
www.hunthalejones.com

t. 415-512-1300  
f. 415-288-0288

BLDG. B ROOF PLAN

A2.4

SCALE: 1/8" = 1'-0"  
DATE: 05.22.2017  
REVISED DATE: 01.02.2019  
PROJECT: 335005.00

# EXHIBIT K.3 - BUILDING C ROOF PLAN

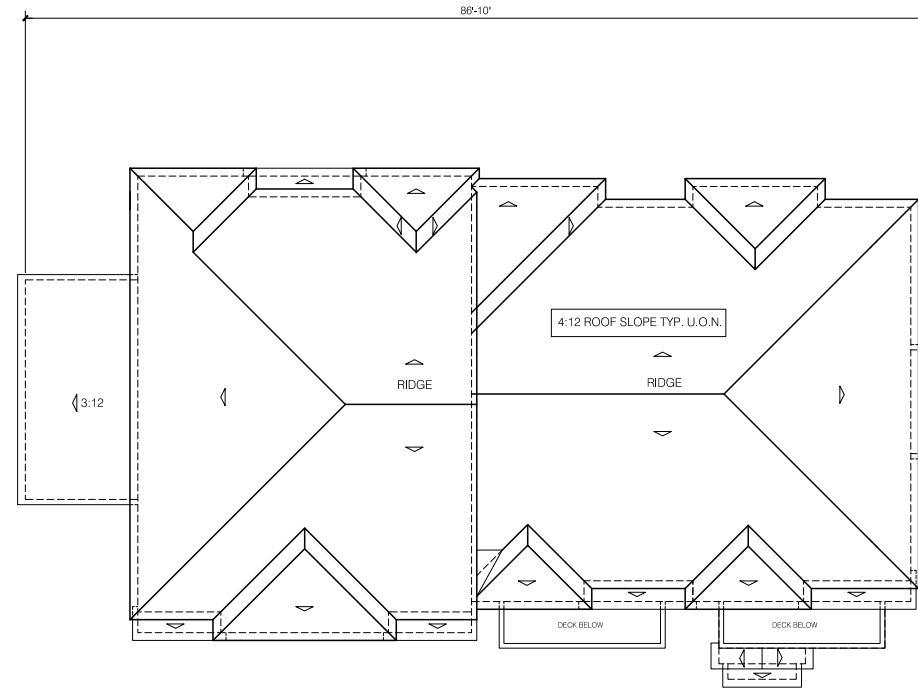

BUILDING C ROOF PLAN

BUILDING C - BROADMOOR VILLAGE

BROADMOOR VILLAGE

311 MACARTHUR BLVD.  
SAN LEANDRO, CA



Architecture | Planning | Interiors

444 Spear Street, Suite 105  
San Francisco, CA 94105  
www.hunthalejones.com

t. 415-512-1300  
f. 415-288-0288

BLDG. C ROOF PLAN

A3.4

SCALE: 1/8"=1'-0"  
DATE: 05.22.2017  
REVISED DATE: 01.02.2019  
PROJECT: 335005.00

# EXHIBIT L.1 - PLANTING PLAN

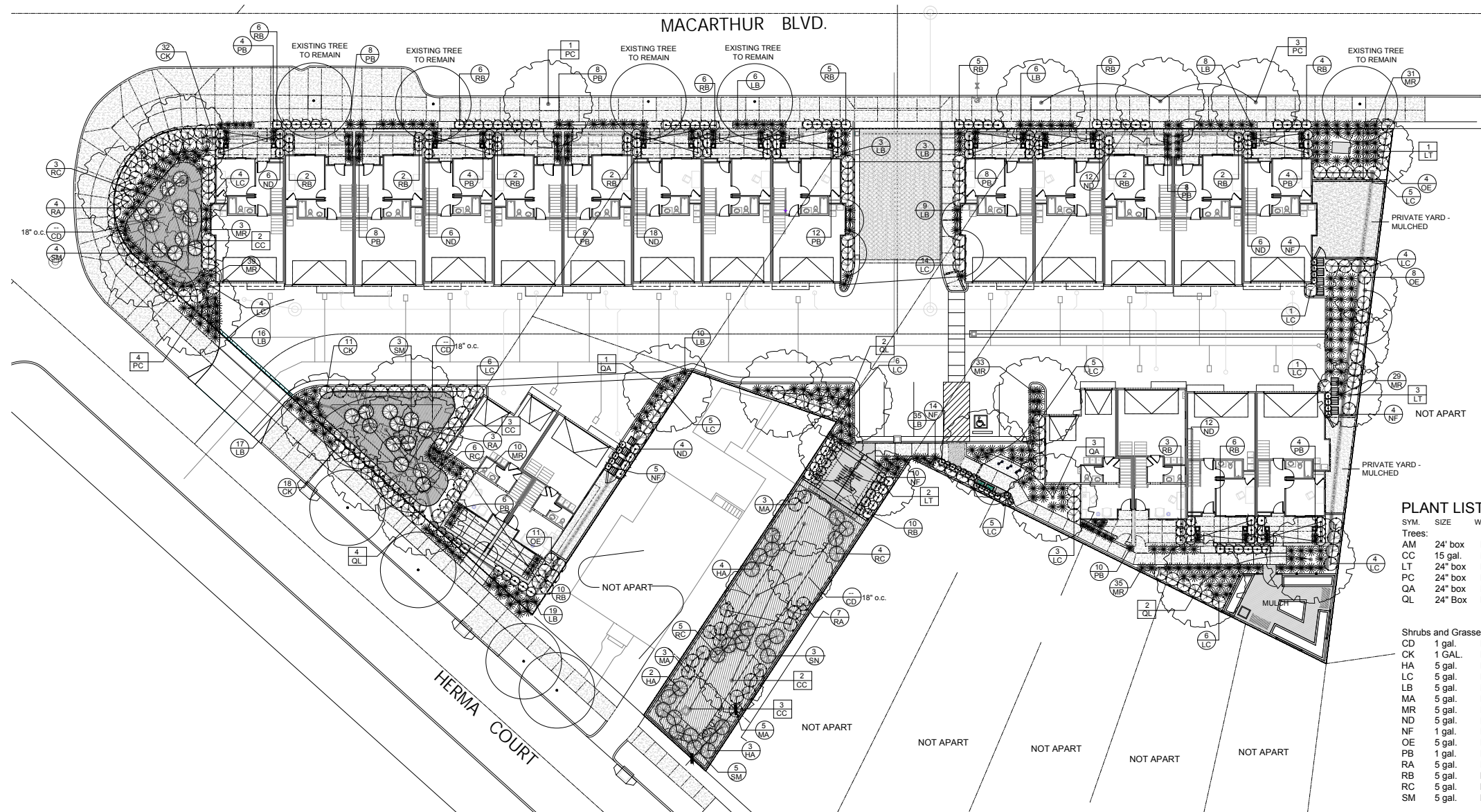

### PLANT LIST:

SYM.	SIZE	WUCOLS	BOTANIC NAME	COMMON NAME
<b>Trees:</b>				
AM	24' box	Low	Arbutus 'Marina'	Strawberry tree
CC	15 gal.	Low	Corylus cornuta subsp. californica	California Hazel
LT	24" box	Low	Lagerstroemia i. 'Muskogee'	Crape Myrtle
PC	24" box	Low	Pistachia c. 'Keith Davey'	Fruitless Chinese Pistache
QA	24" box	Low	Quercus agrifolia	Live Oak
QL	24" Box	Low	Quercus lobata	Valley Oak
<b>Shrubs and Grasses:</b>				
CD	1 gal.	Low	Carex divulsa	European Grey Sedge
CK	1 GAL.	Low	Coprosma kirkii	Kirk's Coprosma
HA	5 gal.	Low	Heteromeles arbutifolia	Toyon
LC	5 gal.	Low	Loropetalum c. 'Sizzling Pink'	Sizzling Pink Fringe Flower
LB	5 gal.	Low	Lomandra longifolia 'Breeze'	Dwarf Mat Rush
MA	5 gal.	Low	Mahonia agufolium	Oregon Grape Holly
MR	5 gal.	Low	Muhlenbergia rigens	Deer Grass
ND	5 gal.	Low	Nandina d. 'Plum Passion'	Heavenly Bamboo
NF	1 gal.	Low	Nepeta x faassenii 'Novanepjun'	Junior Walker Cat Mint
OE	5 gal.	Low	Olea europaea 'Montra'	Little Ollie Dwarf Olive
PB	1 gal.	Low	Phormium tenax 'Black Adder'	New Zealand Flax
RA	5 gal.	Low	Ribes aureum gracillimum	Golden Current
RB	5 gal.	Low	Rhaphiolepis i. 'Ballerina'	Indian Hawthorn
RC	5 gal.	Low	Rosa californica	California Wild Rose
SM	5 gal.	Low	Sambucus mexicana	Mexican Elderberry

### IRRIGATION NOTES:

- All plantings shall be irrigated by an automatic irrigation system with smart controller.
- The irrigation system shall conform to all WELO requirements.
- 100% of the planting shall be low water use plants per WUCOLS.
- All trees shall be placed on a dedicated valve, with deep root irrigation wells.
- An independent irrigation audit to verify water use efficiency shall be required once the landscape installation is complete.

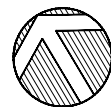

## Broadmoor Village

311 MacArthur Blvd. LLC

311 MacArthur Blvd.

San Leandro, California

## PLANTING PLAN

L-6.1



LEVESQUE DESIGN

1414 BAY STREET, SUITE 100  
ALAMEDA, CALIFORNIA 94501  
(510) 521 6700

DATE: 10/08/2018  
PROJECT: 17-142

# EXHIBIT L.2 - PLANTING DETAILS

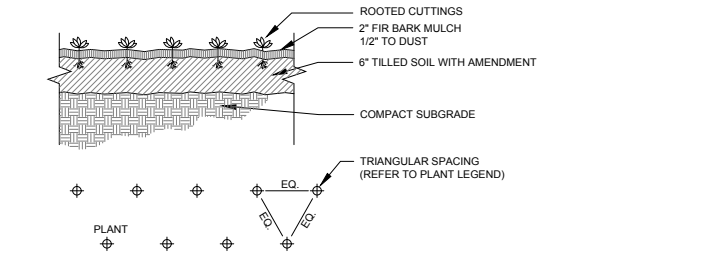

## 1 GROUNDCOVER PLANTING

PLANT QUANTITY CHART

A	B	# PLANTS / S.F.
6" O.C.	5.20"	4.60
8" O.C.	6.93"	2.60
9" O.C.	7.79"	1.78
12" O.C.	10.40"	1.15
15" O.C.	13.00"	0.74
18" O.C.	15.60"	0.51
24" O.C.	20.50"	0.29
30" O.C.	26.00"	0.18
36" O.C.	30.00"	0.12
48" O.C.	40.00"	0.17
72" O.C.	62.35"	0.04

SEE GROUNDCOVER PLANT LIST FOR SPACING OF MASSES PLANTS. THIS DIAGRAM IS FOR INFORMATIONAL PURPOSES ONLY. CONTRACTOR IS RESPONSIBLE FOR ASSURING PROPER COVERAGE AND PLANT COUNTS BASED ON SPECIFIED SPACING.

PLANT SPACING DIAGRAM  
A  
B  
2" MIN.  
EDGE OF PAVEMENT

THIS DIAGRAM DISPLAYS THE PROPER SPACING OF GROUNDCOVERS AND MASSES SHRUB PLANTINGS. PLANTS ARE SHOWN EQUIDISTANT FROM EACH OTHER.

## 2 PLANT SPACING

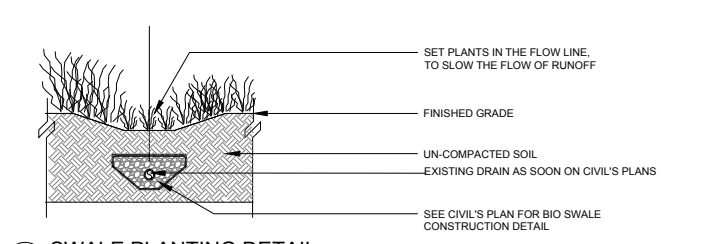

## 3 SWALE PLANTING DETAIL

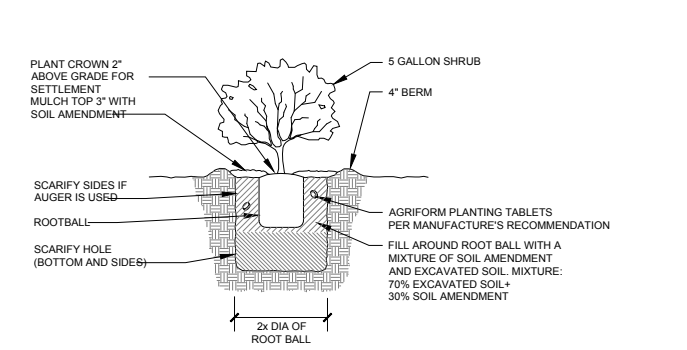
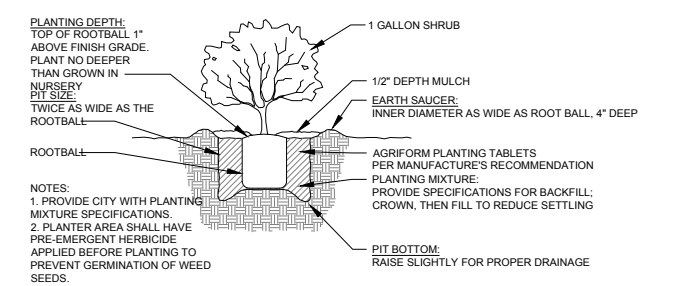

## 4 SHRUB PLANTING DETAILS

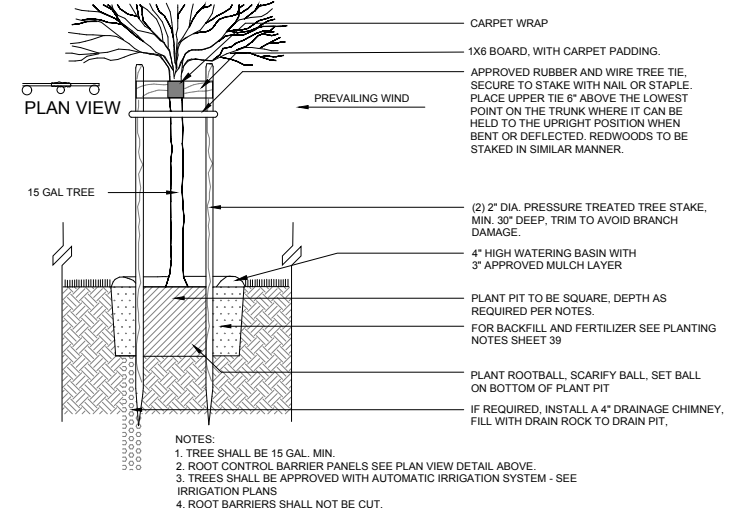
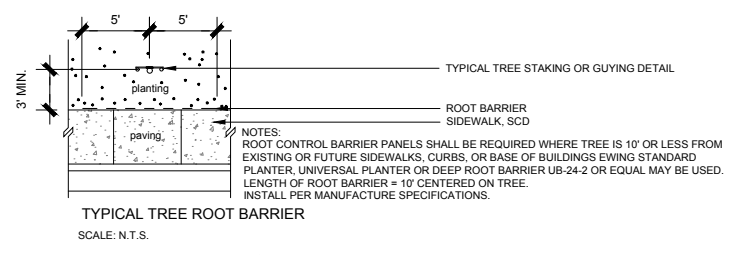

## 6 TREE STAKING DETAIL

**AgriForm® 20-10-5 Planting Tablets Plus Minors**  
Two-Year Planting Tablets for Root Zone Feeding of Trees, Shrubs and Ground Covers

**NEW LANDSCAPE PLANTING DIRECTIONS:**

- Dig planting hole deeper and wider than the soil ball of the plant.
- Backfill hole to that proper planting depth is achieved.
- Place plant in the hole and backfill to halfway point.
- Do not place tablets in the bottom of the planting hole.
- Place AgriForm Tablets in the hole about 1-2 inches away from root tips.
- Finish filling the hole around the plant to grade level.

**INDOOR/OUTDOOR CONTAINERS:**

- Make one hole per tablet 2-3 inches in from edge of container 6-8 inches deep.
- Insert tablets and close holes.

**ESTABLISHED LANDSCAPE TREES AND SHRUBS:**

- Drill or punch holes 6-8 inches deep around dripline and between dripline and trunk.
- Insert tablets and close holes.

**GUARANTEED ANALYSIS**

Total nitrogen (N)	20.00%
2.0% urea nitrogen	30.00%
4.0% slow release nitrogen*	
13.0% water soluble nitrogen	10.00%
Available phosphorus (P2O5)	1.00%
Soluble potash (K2O)	5.00%
Calcium (Ca)	1.00%
Magnesium (Mg) (Total)	0.50%
Sulfur (S) (Total)	1.00%
2.0% combined sulfur (S)	
Boron (B)	0.04%
Copper (Cu) (Total)	0.01%
0.01% water soluble copper (Cu)	
Zinc (Zn) (Total)	0.01%
0.01% water soluble zinc (Zn)	
Manganese (Mn) (Total)	0.01%
0.01% water soluble manganese (Mn)	
Zinc (Zn) (Total)	0.01%
0.01% water soluble zinc (Zn)	

**BID SPECIFICATIONS:**  
Disruptive planting tablet shall be nitrogen component, long lasting and slow release. Weight of 5, 10 and 20 grams with a Nitrogen (N), Phosphorus (P) and Potassium (K) analysis of 20-10-5 and once element derived from the water found in the Guaranteed Analysis.

**QUESTIONS:**  
If you have any questions regarding the use of this product, feel free to call TOLL FREE 1-800-892-4229 or visit [www.compost.com](http://www.compost.com).

© 2009 The Scotts Company LLC, Marysville, Ohio 45750. World Rights Reserved. Printed in U.S.A. 87228 Revised 0/0

## 5 FERTILIZER

**Broadmoor Village**  
311 MacArthur Blvd. LLC  
311 MacArthur Blvd.  
San Leandro, California

## PLANTING DETAILS



**LEVESQUE DESIGN**  
**L-6.2**  
1414 BAY STREET, SUITE 100  
ALAMEDA, CALIFORNIA 94501  
(510) 521 6700  
DATE: 10/08/2018  
PROJECT: 17-142

# EXHIBIT L.3 - PATIO, WALL, GATE AND PICNIC AREA DETAIL

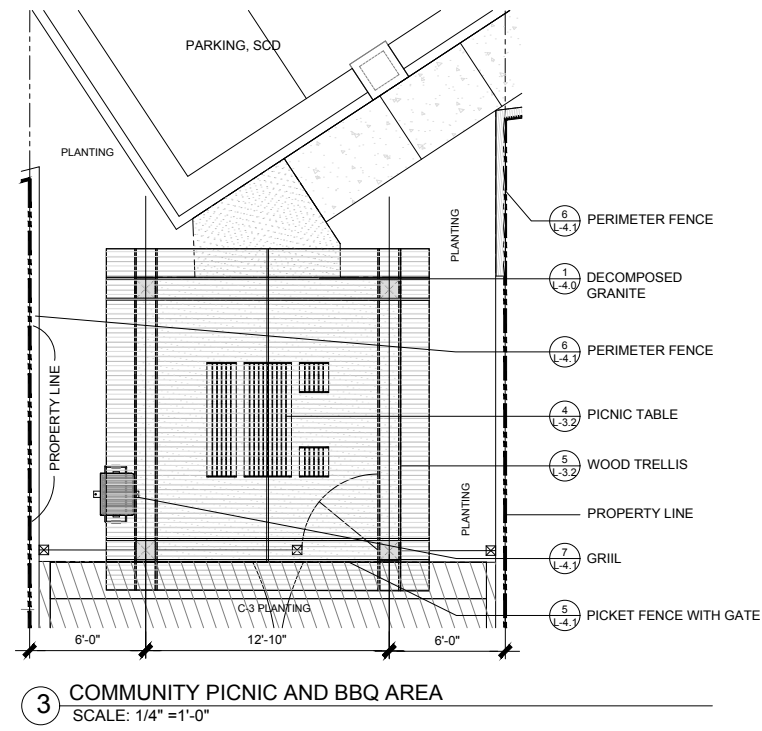
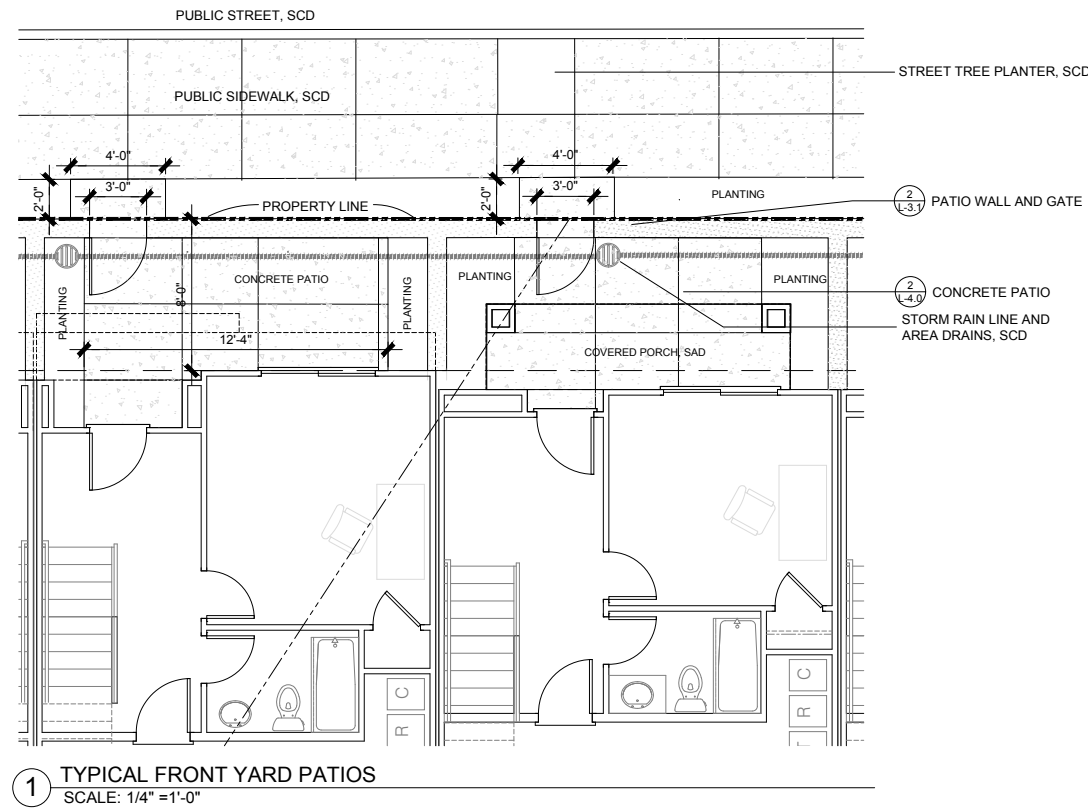

4 PICNIC TABLE: ADA ACCESSIBLE  
SEE DETAIL 1, SHEET L-4.2

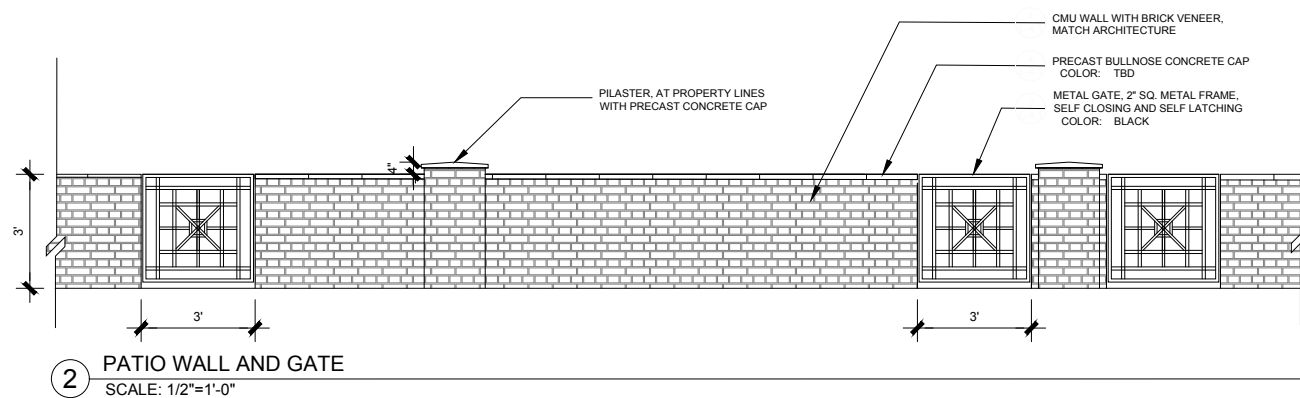

4 WOOD TRELLIS  
SEE DETAIL 1, SHEET L-4.2

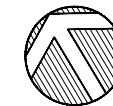

**Broadmoor Village**

311 MacArthur Blvd. LLC

311 MacArthur Blvd.

San Leandro, California

DETAIL PLANS

L-3.1



LEVESQUE DESIGN

1414 BAY STREET, SUITE 100  
ALAMEDA, CALIFORNIA 94501  
(510) 521 6700

DATE: 10/08/2018  
PROJECT: 17-142

# EXHIBIT L.4 - PERIMETER FENCE, TRELLIS, AND GRILL DETAIL

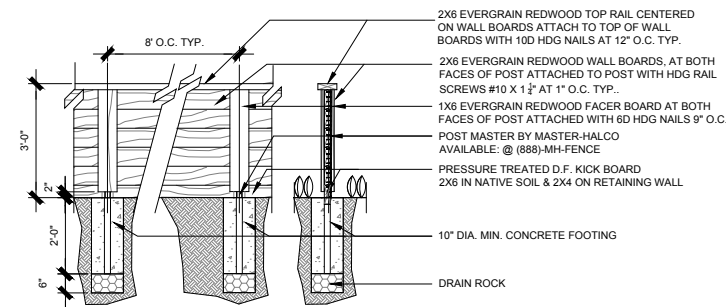

**3** LOW PERIMETER FENCE  
SCALE: 1/2"=1'-0"

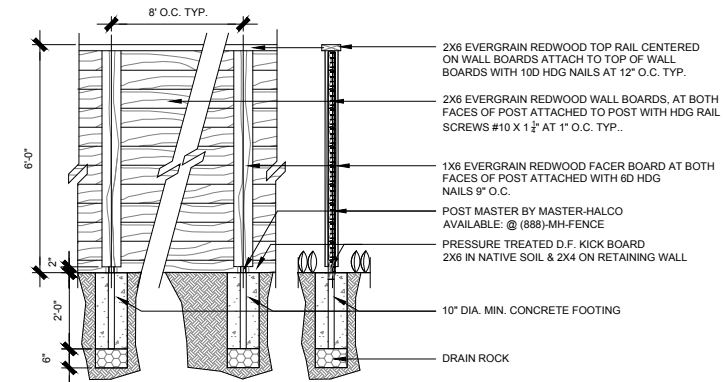

**6** PERIMETER FENCE  
SCALE: 1/2"=1'-0"

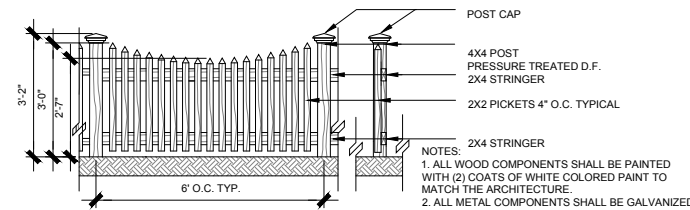

**4** PICKET FENCE  
SCALE: 1/2"=1'-0"

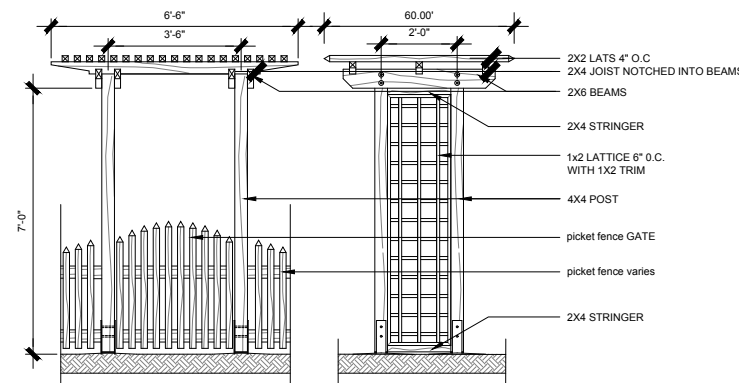

**5** ENTRY TRELLIS: COMMUNITY GARDEN  
SCALE: AS SHOWN

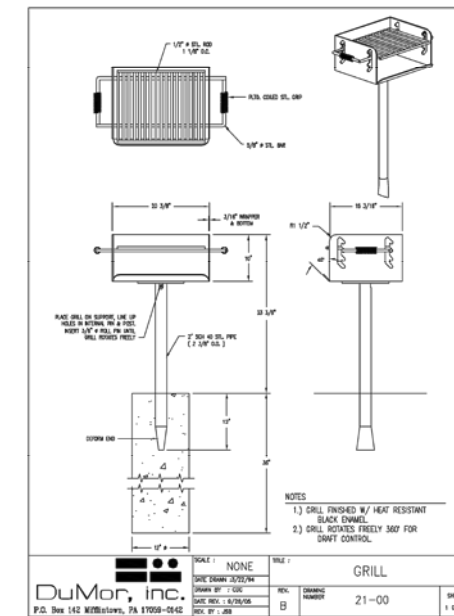

**7** GRILL

**Broadmoor Village**

311 MacArthur Blvd. LLC

311 MacArthur Blvd.

San Leandro, California



LEVESQUE DESIGN

1414 BAY STREET, SUITE 100  
ALAMEDA, CALIFORNIA 94501  
(510) 521 6700

**DETAILS**

**L-4.1**

DATE: 10/08/2018  
PROJECT: 17-142



# EXHIBIT L.5 - TRELIS, PICNIC TABLE, RAISED PLANTER, ARBOR DETAIL

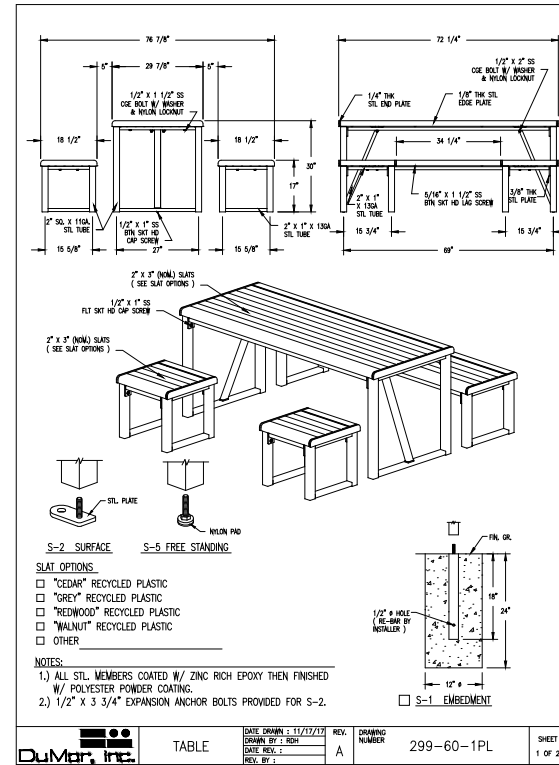

1 PICNIC TABLE

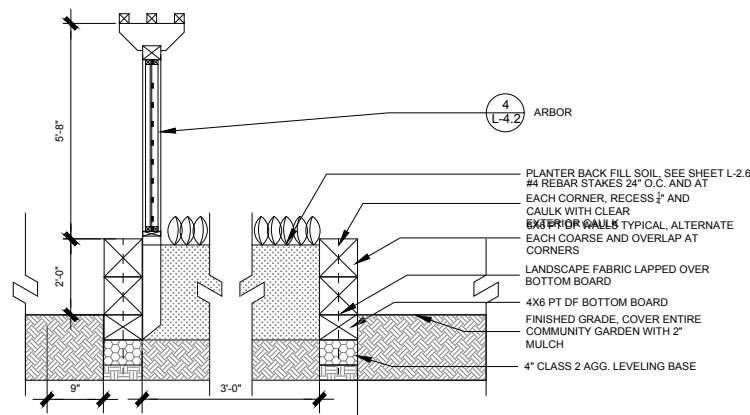

2 RAISED PLANTER  
SCALE: 1" = 1'-0"

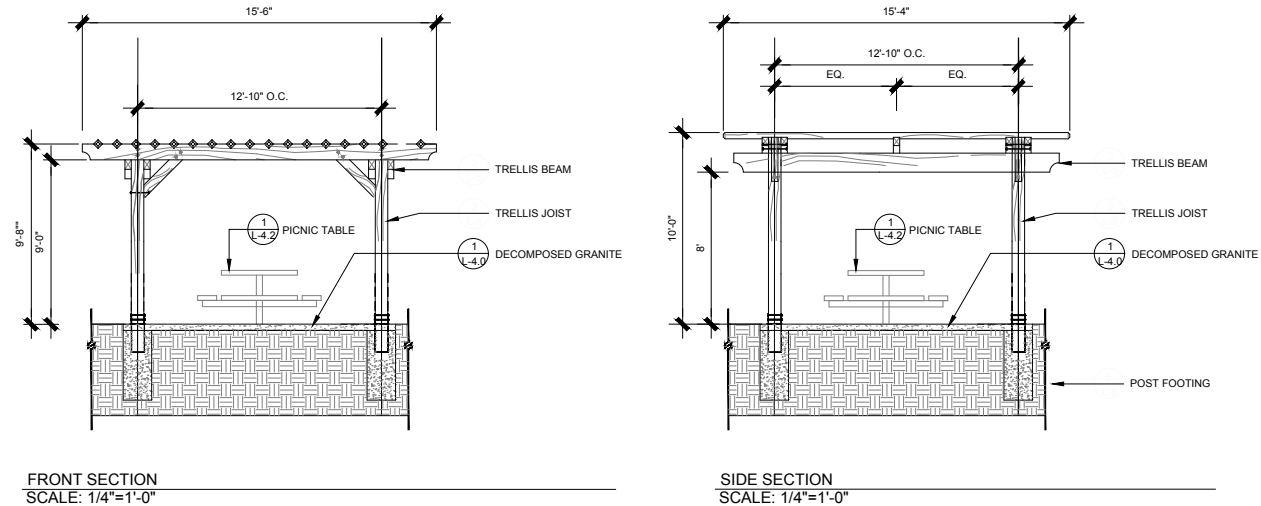

3 TRELIS  
SCALE: AS SHOWN

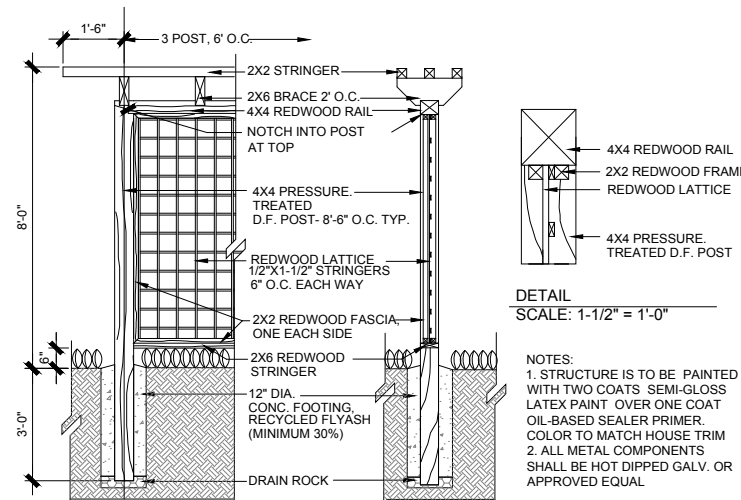

4 ARBOR  
SCALE: 1/2"=1'-0"



5 TEAK BENCH - 6'  
MODEL: WINDEMERE 6' TEAK W/ WATER AND STAIN GUARD  
AVAILABLE: COUNTRY CASUAL TEAK

Broadmoor Village

311 MacArthur Blvd. LLC

311 MacArthur Blvd.

San Leandro, California

DETAILS

L-4.2



LEVESQUE DESIGN

1414 BAY STREET, SUITE 100  
ALAMEDA, CALIFORNIA 94501  
(510) 521 6700

DATE: 10/08/2018  
PROJECT: 17-142

# EXHIBIT L.6 - CONCRETE PAVERS, BIKE RACK, WALL LIGHT, MAILBOXES



1 CONCRETE PAVERS (80 MIL)  
SCALE: NA

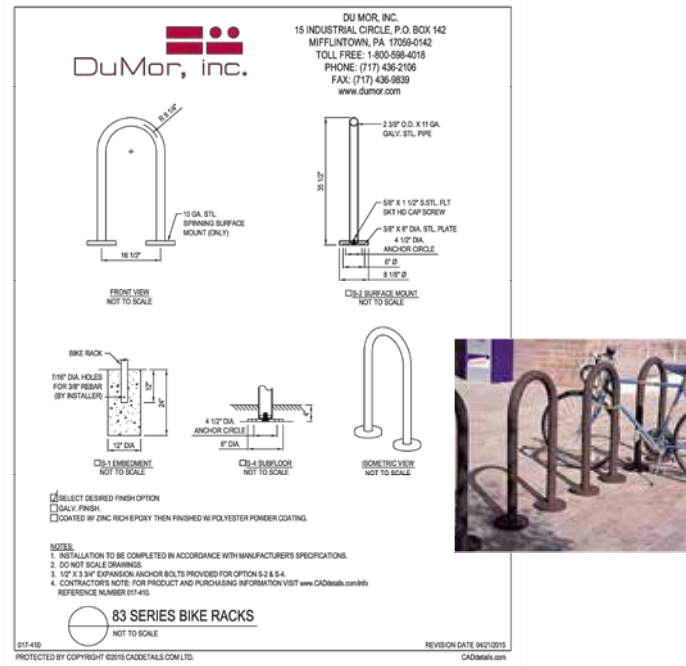

2 BIKE RACK  
SCALE: AS SHOWN



3 WALL LIGHT

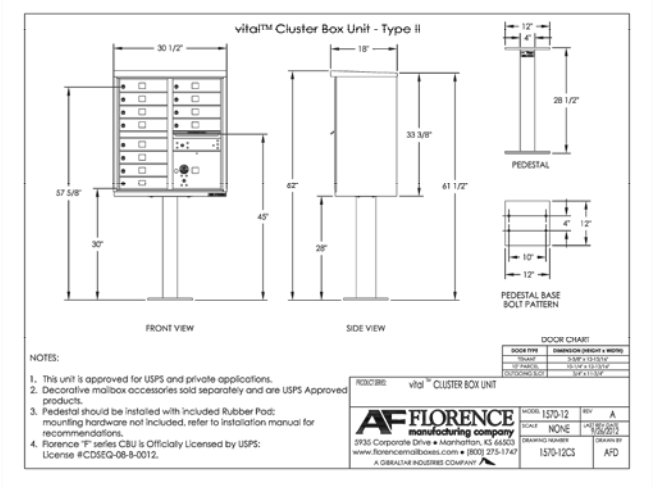

4 MAILBOX

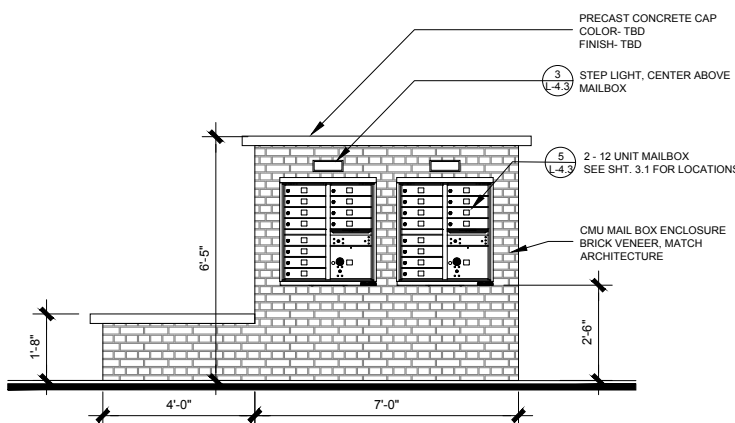

5 MAILBOX ENCLOSURE  
SCALE: 1/2"=1'-0"

**Broadmoor Village**  
311 MacArthur Blvd. LLC  
311 MacArthur Blvd.  
San Leandro, California

**DETAILS**  
**L-4.3**

LEVESQUE DESIGN  
1414 BAY STREET, SUITE 100  
ALAMEDA, CALIFORNIA 94501  
(510) 521 6700

DATE: 10/08/2018  
PROJECT: 17-142

# EXHIBIT L.7 - PLANTING NOTES

## PLANTING NOTES

- The scope of the planting work includes, but is not limited to the following:
  - Ordering and delivery of the plant materials to site.
  - Soil preparation and conditioning.
  - Fine grading of all landscape areas, including supplying and installing amendments or imported topsoil as described on the drawings and as required by the recommendations of the soils testing report.
  - Coordination of additional drainage work as shown on the drawings.
  - Soil Testing by Landscape Contractor.
  - Installation of plant materials.
  - Ninety (90) day maintenance period.
  - Replacement of all unsatisfactory plant materials.
  - Final Approval
  - Warranty
- The Landscape Contractor shall notify the site contractor and Landscape Architect of any discrepancy between the Drawings and/or Specifications and actual conditions. Specifications shall take precedence. No work shall be done in any area where there is such a discrepancy until the discrepancy has been clarified and a written response has been given by the Landscape Architect.
- All work shall be performed by persons familiar with planting work and under supervision of a qualified planting foreman.
- Within 30 days after award of contract the Landscape Contractor shall arrange with a nursery to obtain all plant materials noted on the plans and have them available for inspection by the Owner and the Landscape Architect. Upon approval of the plant material, the contractor shall purchase the material and have it segregated and grown for the job. The deposit necessary for such contract growing (if required) is to be born by the Landscape Contractor. If travel is required by the L.A. to inspect plant material, cost of travel shall be at the contractor's expense.
- The Landscape Contractor shall arrange and pay provide for 4 (four) sustainable agricultural suitability and soil fertility tests to be performed on the rough graded soil. Two test shall include soil samples taken at a depth of 18". Two test shall include samples of soil taken at between 6" and 12". The Landscape Architect shall approve of the soil testing lab in advance. The soil lab shall make recommendations for use of organic and locally available amendments. Locations for soil samples shall be determined by the Landscape Architect. Soil amendments shall be thoroughly and evenly incorporated into the top 12" of all planter and lawn areas. After amendment, the soil shall have an organic content of 5.0% min. The results of these tests shall be reviewed by the Owner, General Contractor and the Landscape Architect for a decision prior to amending the soil. This analysis shall be conducted and paid for by the Landscape Contractor. Recommendations for amendments contained in this analysis are to be carried out before planting occurs. Such changes are to be accompanied by equitable adjustments in the contract price if/when necessary. For bid purposes include:
  - 6 cubic yards of Composted Greenwaste/Thousand Sq. Ft.
  - 10 pounds of Soil Sulfur /Thousand Sq. Ft.
- All trees are to be staked or guyed as shown in the staking/guying diagrams (see Planting Plan sheets). Contractor shall establish one in place example of each for approval by the Landscape Architect. Cut stake height as directed by the Landscape Architect.
- The Landscape Contractor shall be responsible for providing all plant material indicated on the plans, unless otherwise directed in writing. Contractor to submit unit quantities and unit costs as a part of his bid. Cost for additional plants requested and approved by Owner and/or Landscape Architect will be based on this bid unit price.
- Plant locations are diagrammatic and are to be adjusted in the field as necessary to screen utilities but not impede access.
- The Landscape Architect reserves the right to make substitutions, additions, and deletions in the planting scheme as he feels necessary while work is in progress. Such changes, with written authorization, are to be accompanied by equitable adjustments in the contract price if and when necessary.
- All ground cover planting areas and plant pits shall be top-dressed with 3" layer of Monterey Dune Natural Mulch, available from WMEarthcare, 1-877-963-2784 or approved equal. Submit sample to Landscape Architect for approval prior to ordering. Material shall not be a redwood product.
- The planting backfill mix shall consist of 75% (by volume) native topsoil (with no rocks larger than 2" diameter) mixed with 25% approved soil amendment.
- Materials Delivery and Storage: Manufactured materials shall be delivered in original containers with brand and maker's name marked thereon. Materials in broken containers or showing evidence of damage will be rejected and must be immediately removed from the site. Odorous materials shall not be brought to the site until they are to be used.
- Contractor shall provide dust alleviation and control measures during the course of the work to the Owner's satisfaction at no additional costs to the contract.

- Plant Material Specifications and Quantities: Plant materials shall be furnished in quantities required to complete the work as indicated on the drawings and shall be of species, kinds, sizes, spacing, etc., specified in the drawings herein.
  - Plant material shall conform with American Association of Nurseryman Standards, ANSI Z60.1, in all ways.
  - Nomenclatures: Plant Names listed on drawings conform to Standardized Plant Names established by American Joint Committee on Horticultural Nomenclature, except that for names not covered therein, the established custom of naming plants by the nursery trade shall be followed.
  - Right of inspection for approval or rejection is reserved at the place of growth or on the project site at any time upon delivery or during the work. Plants shall be inspected for size, variety, condition, defects, or injury. Notify the Landscape Architect as to place of growth for inspection of plants within one month of award of contract.
  - No plant shall be bound with wire or rope at any time so as to damage the bark or break branches.
  - Dimensions: If applicable, height and spread of specimen plant materials are specified on the drawings. Measurements shall be made with materials in normal position without support of branches. Plants specified by container size shall be equal in size to similar plants in local retail nurseries.
  - Plants shall not be pruned prior to delivery, except as authorized by the Landscape Architect.
- Fine Grading and Soil Preparation:
  - The current site is at final grade. The contractor shall maintain existing grading and ensure positive drainage away from the building foundation.
  - All planting areas shall provide positive runoff at a minimum 2 percent slope without pockets or low points.
  - All planting areas shall be cleaned of weeds and debris prior to any soil preparation or grading work. Noxious weeds and grasses shall be removed by the roots wherever they are found at any stage of the work. Weeds and debris shall be disposed of off the site. Contractor shall meet with Landscape Architect before removing any existing shrubs and groundcover.
  - Soil contaminants by cement, paint, plaster, herbicides, or other construction debris shall be removed from the site and replaced with soil at no extra cost to the Owner. Replacement soil shall be reviewed by the Landscape Architect prior to placement.
  - Moisture Content: Soil shall not be worked when moisture content is so great that excessive compaction will occur nor when it is so dry that there will be dust in the air or that clods will not readily break. Water shall be applied, if necessary, to bring soil to an ideal moisture content for planting.
- Planting Procedures:
  - Do not install plant materials until all exterior construction work has been completed and sprinkler systems have been installed and tested. Planting areas shall have been graded and prepared as specified and shall be approved by the Landscape Architect.
  - Install drainage well in tree pits which do not drain. Fill tree pits with 18" of water and let settle for 24 hours. Pits with 12" or more of standing water shall have an 8" diameter by 36" deep well filled with drain rock (below bottom of plant pit). Cover top of well with a 24" square piece of filter fabric. Install per written authorization by the Owner. Provide a unit price quote per tree in the bid.
  - Before excavation, plants in containers shall be placed as indicated on the planting plan bringing any conflict with underground utility lines to the attention of the Landscape
  - Excavate square shaped and vertical sided holes to the sizes and depths indicated on the Drawings. Scarify the sides and bottom of all holes.
  - Remove containers, including boxes, prior to backfilling.
  - Verify that plants are not root bound or girdled, and that the primary leader is intact.
  - Remove any solid rock encountered to a depth of not less than 2 feet below the bottom of plant container. If existing conditions prevent this, bring the condition to the attention of the Landscape Architect for a solution.
  - Backfill the planting holes with the special backfill mix herein specified, see Planting Note 11.
  - Water-settle backfill areas thoroughly or compact by other approved method after planting so plants do not settle.
  - Place "Best" products fertilizer tablets or Agriform Plant Tablets in holes, per manufacturer's written recommendations, at the following rates:
    - 1-Gallon Containers: 2 tablets @ 21 grams.
    - 5-Gallon Containers: 4 tablets @ 21 grams.Larger sized plants per manufacturer's recommendations
- Inspections -Notify Owner's Authorized Representative at least seven (7) days in advance of an anticipated inspection. Inspections are as follows.
  - Commencement of Establishment and Maintenance work.
  - At thirty (30) day intervals through the maintenance period.
  - Completion of the Establishment and Maintenance work - Final walk-through, ten (10) days before the end of the maintenance period.
- Establishing Maintenance Period:
  - Start of Maintenance - Establishment and Maintenance period shall not start until all elements of the landscape construction, including planting and irrigation for the entire project are complete. Project will not be segmented into maintenance phases, unless specifically authorized in writing by the Owner's Authorized Representative.

- Request an inspection to begin the Establishment and Maintenance period after planting and related work has been completed in accordance with the Contract Documents. All planting shall be complete at the time of inspections. If such criterion is met to the satisfaction of the Owner's Authorized Representative and the Landscape Architect, written notification shall be issued to the Contractor to start the Establishment Maintenance period, noting the effective beginning and ending date of completion.
- Plant Establishment & Maintenance:
  - Protection: Work under this Section shall include complete responsibility for maintaining adequate protection for all areas. Any area damage by the maintenance contractor, including paved areas, shall be repaired at no additional expense to the Owner.
  - Continuously maintain all plantings in areas included in the Contract from the beginning of the Contract work, during the progress of work, and for a period of 90 days after certified completion of all work until final acceptance of all contract work. Maintenance shall be performed at intervals of not more than ten (10) days.
  - Scope: Continuous maintenance and operations of the irrigation system, cultivating, weeding, trimming, pruning, adjustment of planting depth, fertilizing, spraying, and debris removal and clean-up, insect, pest, fungus, and rodent control, and any other operations are to be included in this scope of work to assure healthy, normal growth.
  - Fertilizing:
    - Fertilize all planting with the following or as noted in the required Horticulture Soils Report. At the end of the first 30 day and at 30 day intervals, apply top dress fertilizer. The fertilizer shall be 16% nitrogen, 6% phosphoric acid, 8% potash unless otherwise specified in the soils report. Fertilizer shall be mixed by a commercial fertilizer supplier.
    - After application, water fertilizer thoroughly into the soil.
    - Avoid applying fertilizer to the rootball or base of main stems; rather, spread evenly under the plant drip line.
  - Weed Control  
Weeding, Cultivating, and Cleanup: Planting areas shall be kept neat and free from weeds and debris at all times and shall be manually weeded at not more than 10-day intervals. Said areas shall be weed free at the end of the Maintenance Period. Apply pre-emergent weed control per city standards, verify compatibility of herbicide with the plant material. Do not use material which inhibits specified plant material's growth.
  - Lawn Maintenance  
Maintenance of lawns shall consist of weeding, watering, mowing, treatment of fungus disease and insect pests, repair of erosion, fertilizing and all incidental work necessary to maintain turf satisfactory to the Owner. All areas sodded shall be mowed weekly beginning 14 days after sodding at a height no less than 2". All areas seeded shall be mowed only after lawn reaches 3" in height; lawn shall not be cut lower than 3" at its first mowing. After first mowing, lawn shall be mowed weekly at a height of no less than 2".
  - Tree and Shrub Care
    - Maintain large enough basin around plants so hat enough water can be applied to establish moisture throughout the major root zone. When hand water, use a water wand to break the force. maintain mulch at a depth of 3" minimum depth to reduce evaporation and frequency of watering.
    - Pruning Trees: Prune trees to develop permanent scaffold branches that are in diameter than the trunk or branch to which they are attached; which have vertical spacing from 18" to 48" and radial orientation so as not to overlay one another, to eliminate diseased or damaged growth; to eliminate narrow V-shaped branch forks that lack strength; to reduce and wind damage by thinning out crowns to maintain growth within space limitation; to maintain a natural appearance; to balance crown with roots.
    - Trees shall not be topped and shall be allowed to grow to the full genetic height and habit. Under no circumstance will striping of lower branches (raising-up) of young trees be permitted. Lower branches shall be retained in a "tipped back" or pinched condition with as much foliage as possible to promote caliper trunk growth(tapered trunk). Lower branches can be cut flush with the trunk only after the tree is able to stand erect without staking or other support. Remove sucker growth if deemed appropriate by the Owner's authorized representative.
    - Thin out evergreen trees and shape when necessary to prevent wind storm damage. The primary pruning of deciduous trees shall be done during the dormant season. Prune damaged trees or those that constitute health or safety hazards at anytime of the year as required to eliminate unsafe conditions.
    - Trimming Shrubs: The objective of shrub pruning is the same as for trees. Do not clip shrubs into balled or boxed forms unless such is required by the design and directed by the landscape architect. Make pruning cuts at lateral branches or buds or flush with the trunk. "Stubbing" will not be permitted.
    - Staking and Guying: Remove stakes and guys as soon as they are no longer needed. Periodically inspect stakes to prevent girdling or rubbing that causes bark wounds. Replace broken stakes and ties with specified materials. All stakes shall be removed at one year after completed installation, if not sooner.
  - Replacements: The contractor shall replace any plant materials that die or are damaged. Replacement shall occur within seven (7) days of plant death or damage. Replacements shall be made to the same Specifications as required for original plantings.
  - At the termination of the Maintenance Period, all plant materials shall be alive, healthy, undamaged, free from infestations, and in flourishing condition. Plantings that do not conform to Specifications shall be replaced and brought to a satisfactory condition before final acceptance of the work can be made.

20. Following the 90 day Maintenance Period, there will be a final inspection by the Owner, Landscape Architect, and the City Representative. Items noted during the final inspection as not in accordance with the maintenance requirements shall be corrected by the Contractor prior to Final Acceptance of the landscape work. The 1 year warranty period shall begin with the Final Acceptance and the Owner's acceptance of the project. A letter documenting Final Acceptance, signed by the Owner's Authorized Representative, the Contractor and the Landscape Architect shall be issued, with the starting date and the completion date of the warranty period.

- Warranty
  - Trees, shrubs, groundcovers and other plant materials shall be guaranteed to take root, grow and thrive for a period of one year after acceptance of the Work by the Owner. Plant materials which do not thrive as the direct result of the installation procedure or maintenance practices during the maintenance period of the installing contractor shall be replaced by the installing contractor. This shall be as determined by the Owner.
  - Plant materials which fail as the result of poor maintenance practices after acceptance of the landscape by the Owner (at the end of the maintenance period) shall be the responsibility of the Owner's maintenance contractor.
  - Trees or other plant materials that die back and lose the form and size originally specified shall be replaced, even though they have taken root and are growing after the die-back.
  - Within fifteen days of written notification by the Owner, remove and replace warranted plant materials which, for any reason, fail to meet requirements of Warranty. Replacements shall be made to the same Specifications required for original materials and shall carry the same Warranty from the time they are replaced.

22. The intent of the layout design and planting is to establish a high quality landscape installation. Future plant growth should require minimum trimming, thinning and pruning of the plant materials. Plant spacing is designed to allow for natural full growth and should not need the removal of some plant materials if over crowding occurs. The planting installations will require maintenance and management, by knowledgeable and trained personnel, to assure a quality project.

23. Water Efficient Ordinance / AB 1881 Requirements  
This project requires compliance with AB 1881, Model Water Efficient Landscape Ordinance, the Maintenance contractor shall provide the following:

- Irrigation schedule based on ET weather-based data and information on the drawings:
  - A regular landscape maintenance schedule;
  - An irrigation audit report of the newly installed irrigation system;
  - Copy of the horticultural soils report per the Planting Note 5, this sheet.
- Penalties by a governing agency for non-compliance and over-water use during the landscape maintenance period shall be the responsibility of the maintenance contractor.
- See the Irrigation Notes on sheet L-5.0

- Irrigation System:
  - The Landscape Contractor shall arrange a meeting with the manufacturer's representative of the irrigation controller to train the maintenance personnel on the controller's proper use. Controller charts and as-builts of the planting and irrigation plans shall be given to the Owner at the end of the maintenance period.
  - Set and program automatic controllers per irrigation schedule. Give the Owner's authorized representative, keys to each controller and written instructions on how to turn the system off in case of emergency.
  - Check system weekly for proper operation and coverage. Lateral lines shall be flushed out after removing the bubbler or two at the end of the lateral.
  - Repair damages to irrigation system at Contractor's expense. Make repairs within one watering period.

- Drainage System
  - All drains in landscaped areas, subsurface drain lines and grates shall be kept free and clear of leaves, litter and debris to ensure proper and free flow of water.
  - Drain lines shall be periodically flushed with clean water to avoid build up of silt and debris.
  - Ensure that at the end of Maintenance period, drainage system is clean and free of debris and silt build up.

- Debris Removal
  - Remove trash in the landscape areas and debris generated by landscape maintenance operations and legally dispose of offsite.

## Broadmoor Village

311 MacArthur Blvd. LLC

311 MacArthur Blvd.

San Leandro, California

## PLANTING NOTES



LEVESQUE DESIGN

# L-6.0

1414 BAY STREET, SUITE 100  
ALAMEDA, CALIFORNIA 94501  
(510) 521 6700

DATE: 10/08/2018  
PROJECT: 17-142

# EXHIBIT M - TOPOGRAPHIC SURVEY

## TOPOGRAPHIC SURVEY BROADMOOR VILLAGE (TRACT 8422) MULTI-FAMILY RESIDENTIAL CITY OF SAN LEANDRO, ALAMEDA COUNTY, CALIFORNIA

### BASIS OF ELEVATIONS

NAIL IN TOP-OF-CURB AT THE EAST RETURN OF THE NORTH-EAST CORNER OF THE INTERSECTION OF MACARTHUR BLVD. & VICTORIA AVE. ELEVATION = 72.66 PER CITY OF SAN LEANDRO DATUM.

### BASIS OF BEARINGS

SOUTHERLY RIGHT-OF-WAY LINE, OF MACARTHUR BLVD. TAKEN AS S59°22'E AS SHOWN ON MAP OF HOLLYWOOD, (28 M. 92).

### SURVEY NOTE

TOPOGRAPHIC SURVEY DATA IS BASED ON A SURVEY FILE PROVIDED BY BAY AREA LAND SURVEYING, DATED OCTOBER 2016.

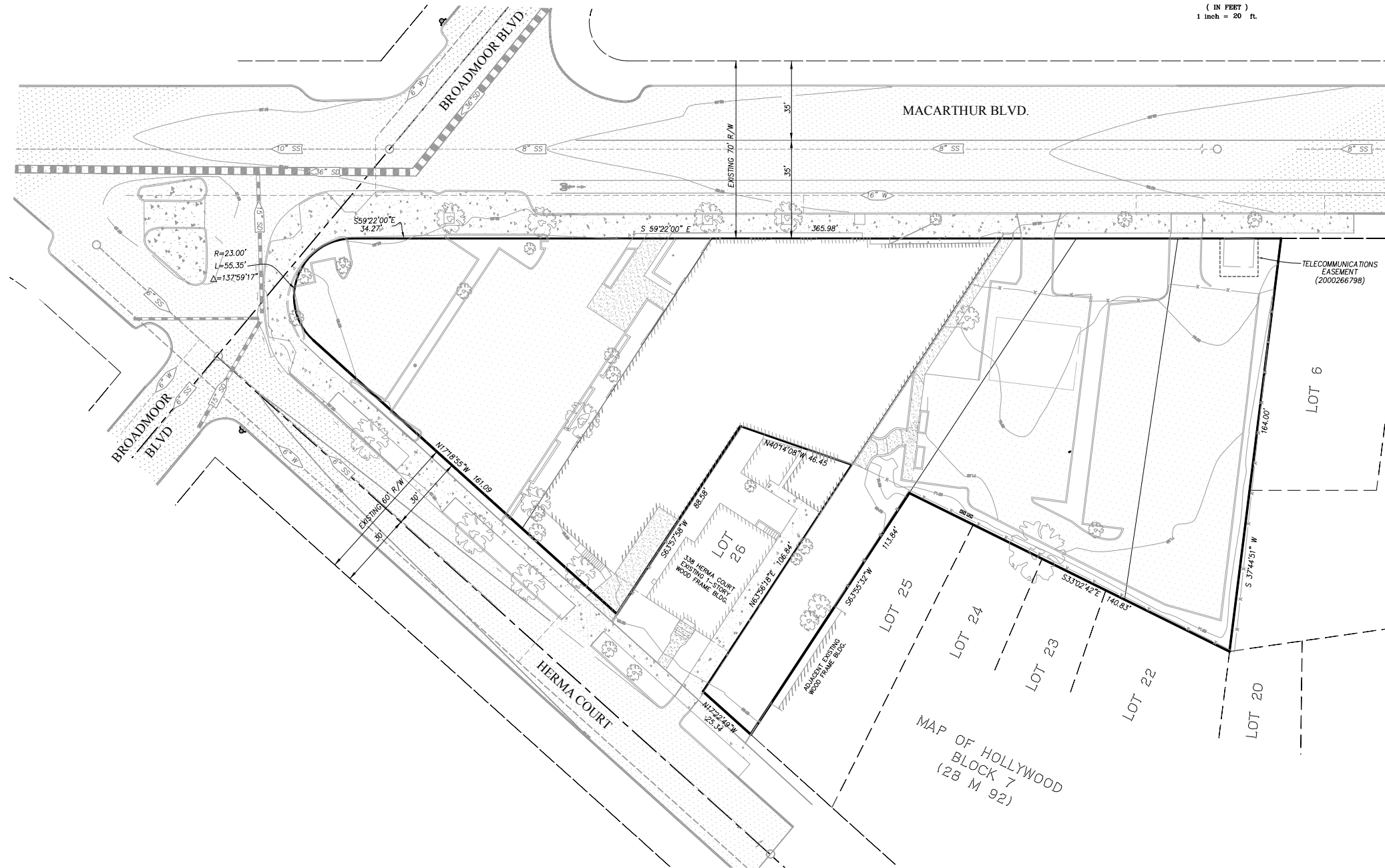
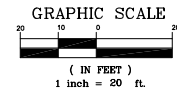

817 Arnold Drive, Ste. 50  
Martinez, CA 94553  
Ph: (925) 476-8499  
www.apexce.net



NO.	REVISIONS	BY	APP.	DATE

TENTATIVE MAP  
TOPOGRAPHIC SURVEY  
BROADMOOR VILLAGE (TRACT 8422)  
SAN LEANDRO, CA

SHEET  
C2

DATE  
10-09-2018

PROJECT #: 17028

# EXHIBIT N.1 - GRADING AND UTILITY PLAN NORTH

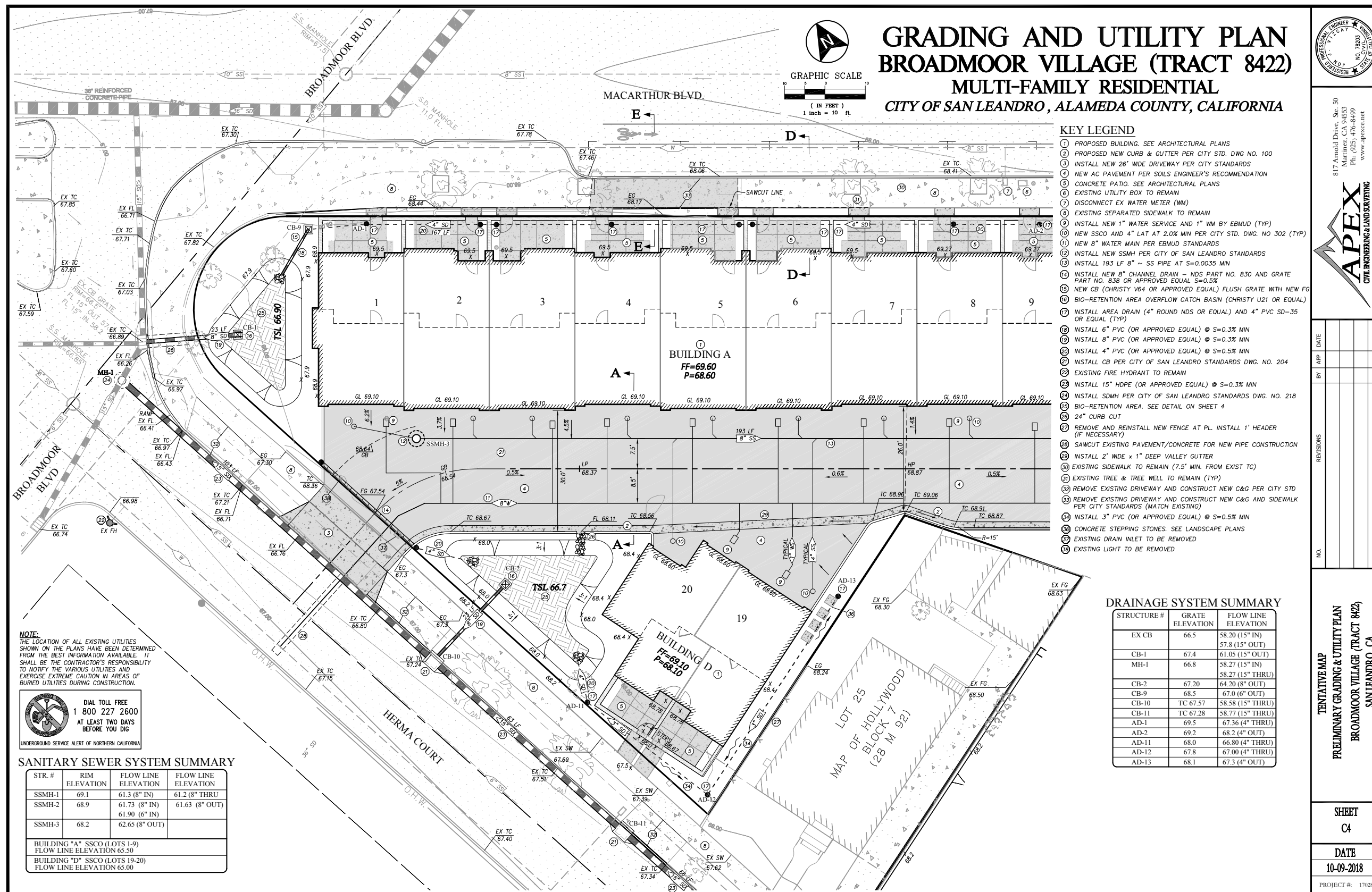

# EXHIBIT N.2 - GRADING AND UTILITY PLAN SOUTH

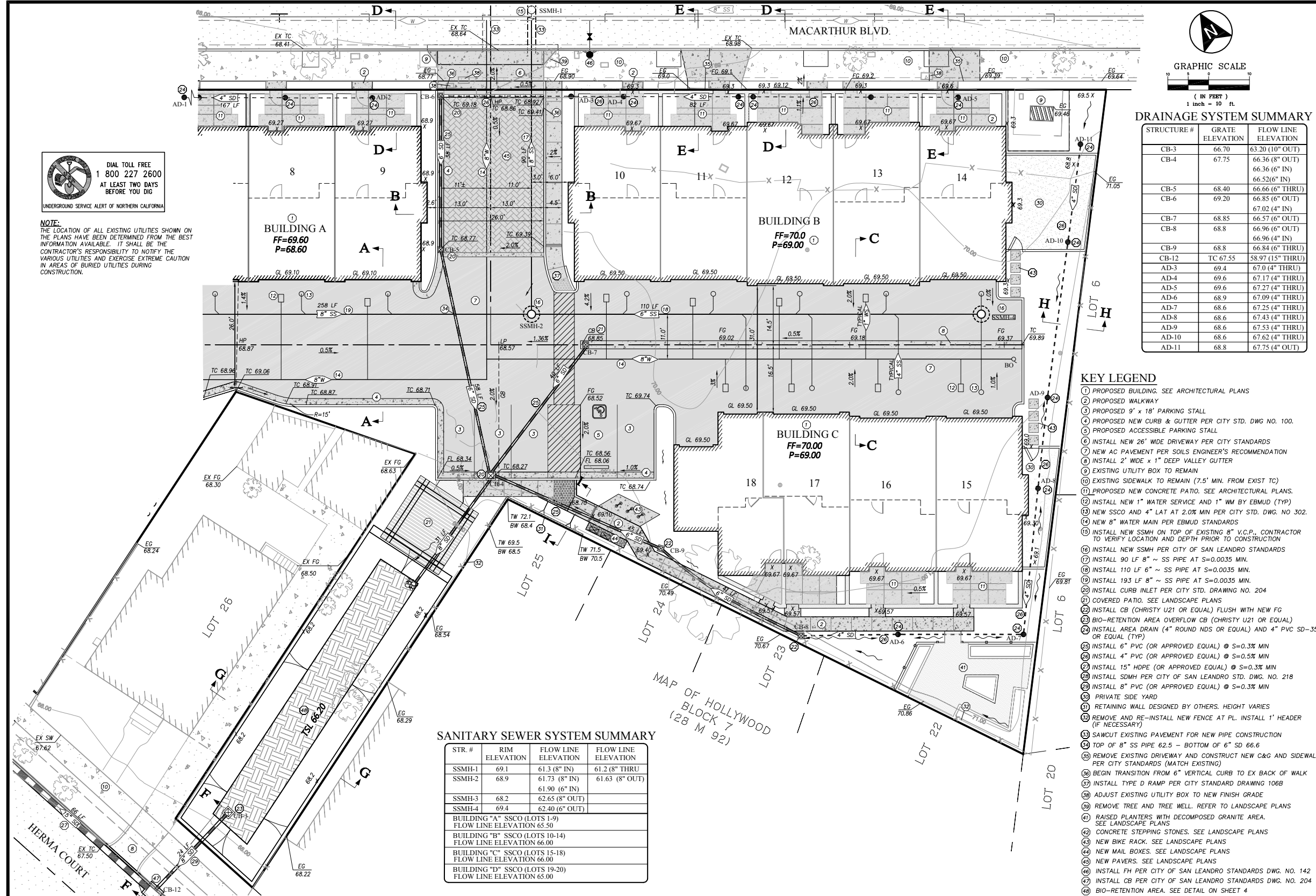

**DIAL TOLL FREE**  
1 800 227 2600  
AT LEAST TWO DAYS  
BEFORE YOU DIG  
UNDERGROUND SERVICE ALERT OF NORTHERN CALIFORNIA

**NOTE:**  
THE LOCATION OF ALL EXISTING UTILITIES SHOWN ON THE PLANS HAVE BEEN DETERMINED FROM THE BEST INFORMATION AVAILABLE. IT SHALL BE THE CONTRACTOR'S RESPONSIBILITY TO NOTIFY THE VARIOUS UTILITIES AND EXERCISE EXTREME CAUTION IN AREAS OF BURIED UTILITIES DURING CONSTRUCTION.

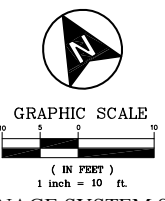

### DRAINAGE SYSTEM SUMMARY

STRUCTURE #	GRATE ELEVATION	FLOW LINE ELEVATION
CB-3	66.70	63.20 (10" OUT)
CB-4	67.75	66.36 (8" OUT) 66.36 (6" IN) 66.52(6" IN)
CB-5	68.40	66.66 (6" THRU)
CB-6	69.20	66.85 (6" OUT) 67.02 (4" IN)
CB-7	68.85	66.57 (6" OUT)
CB-8	68.8	66.96 (6" OUT) 66.96 (4" IN)
CB-9	68.8	66.84 (6" THRU)
CB-12	TC 67.55	58.97 (15" THRU)
AD-3	69.4	67.0 (4" THRU)
AD-4	69.6	67.17 (4" THRU)
AD-5	69.6	67.27 (4" THRU)
AD-6	68.9	67.09 (4" THRU)
AD-7	68.6	67.25 (4" THRU)
AD-8	68.6	67.43 (4" THRU)
AD-9	68.6	67.53 (4" THRU)
AD-10	68.6	67.62 (4" THRU)
AD-11	68.8	67.75 (4" OUT)

### KEY LEGEND

- 1 PROPOSED BUILDING. SEE ARCHITECTURAL PLANS
- 2 PROPOSED WALKWAY
- 3 PROPOSED 9' x 18' PARKING STALL
- 4 PROPOSED NEW CURB & GUTTER PER CITY STD. DWG NO. 100.
- 5 PROPOSED ACCESSIBLE PARKING STALL
- 6 INSTALL NEW 26' WIDE DRIVEWAY PER CITY STANDARDS
- 7 NEW AC PAVEMENT PER SOILS ENGINEER'S RECOMMENDATION
- 8 INSTALL 2' WIDE x 1" DEEP VALLEY CUTTER
- 9 EXISTING UTILITY BOX TO REMAIN
- 10 EXISTING SIDEWALK TO REMAIN (7.5' MIN. FROM EXIST TC)
- 11 PROPOSED NEW CONCRETE PATIO. SEE ARCHITECTURAL PLANS.
- 12 INSTALL NEW 1" WATER SERVICE AND 1" WM BY EBMUD (TYP)
- 13 NEW SSCO AND 4" LAT AT 2.0% MIN PER CITY STD. DWG. NO. 302.
- 14 NEW 8" WATER MAIN PER EBMUD STANDARDS
- 15 INSTALL NEW SSMH ON TOP OF EXISTING 8" V.C.P., CONTRACTOR TO VERIFY LOCATION AND DEPTH PRIOR TO CONSTRUCTION
- 16 INSTALL NEW SSMH PER CITY OF SAN LEANDRO STANDARDS
- 17 INSTALL 90 LF 8" ~ SS PIPE AT S=0.0035 MIN.
- 18 INSTALL 110 LF 6" ~ SS PIPE AT S=0.0035 MIN.
- 19 INSTALL 193 LF 8" ~ SS PIPE AT S=0.0035 MIN.
- 20 INSTALL CURB INLET PER CITY STD. DRAWING NO. 204
- 21 COVERED PATIO. SEE LANDSCAPE PLANS
- 22 INSTALL CB (CHRISTY U21 OR EQUAL) FLUSH WITH NEW FG
- 23 BIO-RETENTION AREA OVERFLOW CB (CHRISTY U21 OR EQUAL)
- 24 INSTALL AREA DRAIN (4" ROUND NDS OR EQUAL) AND 4" PVC SD-35 OR EQUAL (TYP)
- 25 INSTALL 6" PVC (OR APPROVED EQUAL) @ S=0.3% MIN
- 26 INSTALL 4" PVC (OR APPROVED EQUAL) @ S=0.5% MIN
- 27 INSTALL 15" HDPE (OR APPROVED EQUAL) @ S=0.3% MIN
- 28 INSTALL SDMH PER CITY OF SAN LEANDRO STD. DWG. NO. 218
- 29 INSTALL 8" PVC (OR APPROVED EQUAL) @ S=0.3% MIN
- 30 PRIVATE SIDE YARD
- 31 RETAINING WALL DESIGNED BY OTHERS. HEIGHT VARIES
- 32 REMOVE AND RE-INSTALL NEW FENCE AT PL. INSTALL 1" HEADER (IF NECESSARY)
- 33 SAWCUT EXISTING PAVEMENT FOR NEW PIPE CONSTRUCTION
- 34 TOP OF 8" SS PIPE 62.5 - BOTTOM OF 6" SD 66.6
- 35 REMOVE EXISTING DRIVEWAY AND CONSTRUCT NEW C&G AND SIDEWALK PER CITY STANDARDS (MATCH EXISTING)
- 36 BEGIN TRANSITION FROM 6" VERTICAL CURB TO EX BACK OF WALK
- 37 INSTALL TYPE D RAMP PER CITY STANDARD DRAWING 106B
- 38 ADJUST EXISTING UTILITY BOX TO NEW FINISH GRADE
- 39 REMOVE TREE AND TREE WELL. REFER TO LANDSCAPE PLANS
- 40 RAISED PLANTERS WITH DECOMPOSED GRANITE AREA. SEE LANDSCAPE PLANS
- 41 CONCRETE STEPPING STONES. SEE LANDSCAPE PLANS
- 42 NEW BIKE RACK. SEE LANDSCAPE PLANS
- 43 NEW MAIL BOXES. SEE LANDSCAPE PLANS
- 44 NEW PAVERS. SEE LANDSCAPE PLANS
- 45 INSTALL FH PER CITY OF SAN LEANDRO STANDARDS DWG. NO. 142
- 46 INSTALL CB PER CITY OF SAN LEANDRO STANDARDS DWG. NO. 204
- 48 BIO-RETENTION AREA. SEE DETAIL ON SHEET 4

### SANITARY SEWER SYSTEM SUMMARY

STR. #	RIM ELEVATION	FLOW LINE ELEVATION	FLOW LINE ELEVATION
SSMH-1	69.1	61.3 (8" IN)	61.2 (8" THRU)
SSMH-2	68.9	61.73 (8" IN)	61.63 (8" OUT)
		61.90 (6" IN)	
SSMH-3	68.2	62.65 (8" OUT)	
SSMH-4	69.4	62.40 (6" OUT)	
BUILDING "A" SSCO (LOTS 1-9) FLOW LINE ELEVATION 65.50			
BUILDING "B" SSCO (LOTS 10-14) FLOW LINE ELEVATION 66.00			
BUILDING "C" SSCO (LOTS 15-18) FLOW LINE ELEVATION 66.00			
BUILDING "D" SSCO (LOTS 19-20) FLOW LINE ELEVATION 65.00			



817 Arnold Drive, Ste. 50  
Martinez, CA 94553  
Ph: (925) 476-8499  
www.apexce.com



NO.	REVISIONS	BY	DATE

TENTATIVE MAP  
PRELIMINARY GRADING & UTILITY PLAN  
BROADMOOR VILLAGE (TRACT 842)  
SAN LEANDRO, CA

SHEET  
C5  
DATE  
10-09-2018  
PROJECT #: 17028

# EXHIBIT N.3 - SECTIONS

## SECTIONS BROADMOOR VILLAGE (TRACT 8422) MULTI-FAMILY RESIDENTIAL CITY OF SAN LEANDRO, ALAMEDA COUNTY, CALIFORNIA

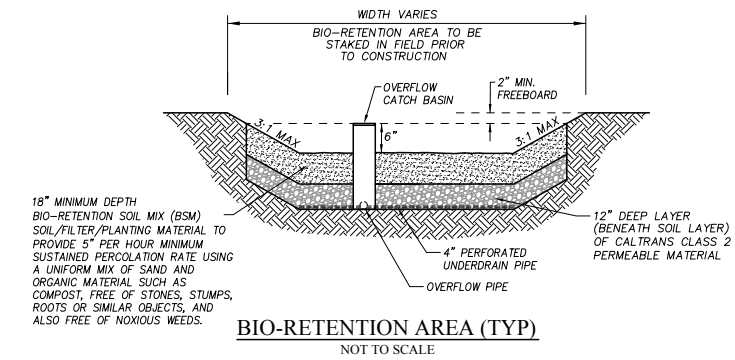
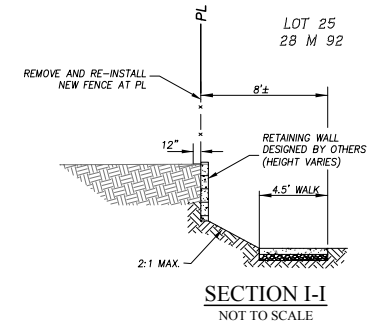
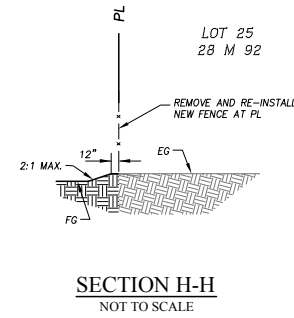
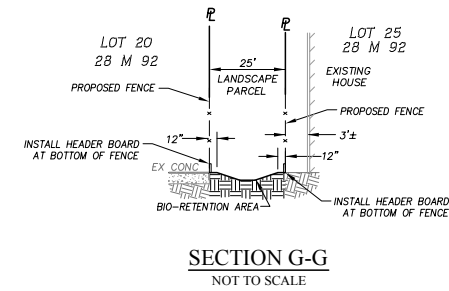
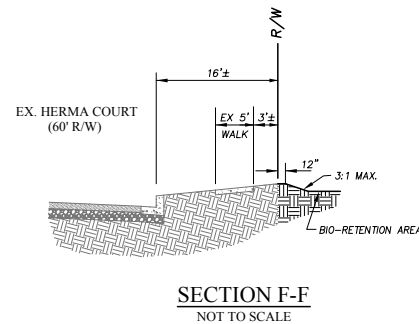
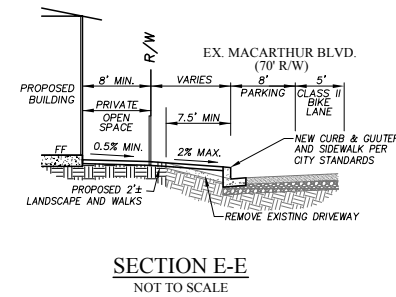
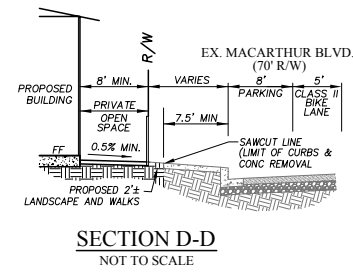
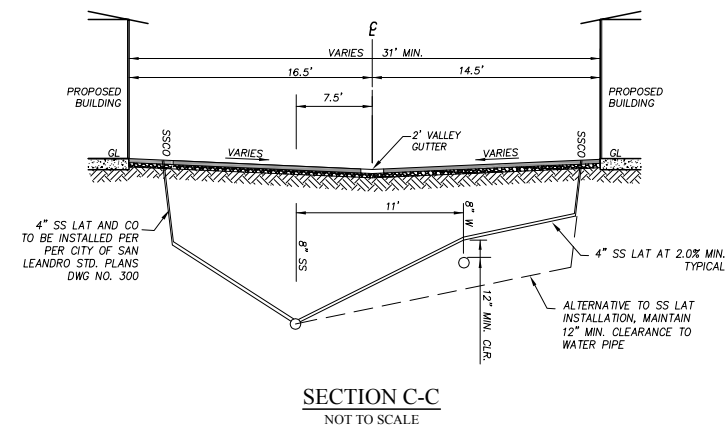
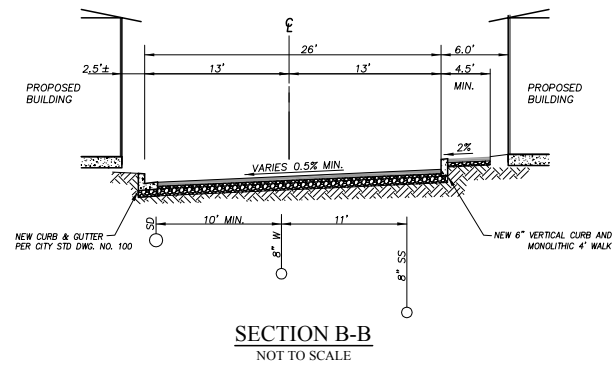
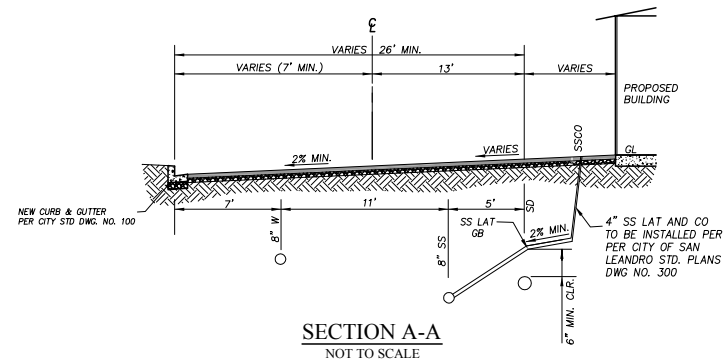

817 Arnold Drive, Ste. 50  
Martinez, CA 94553  
Ph: (925) 476-8499  
www.apexce.net



NO.	REVISIONS	BY	DATE

TENTATIVE MAP  
SECTIONS  
BROADMOOR VILLAGE (TRACT 8422)  
SAN LEANDRO, CA

SHEET  
C7  
DATE  
10-09-2018  
PROJECT #: 17028

# EXHIBIT O - PRELIMINARY C.3 STORM WATER CONTROL PLAN

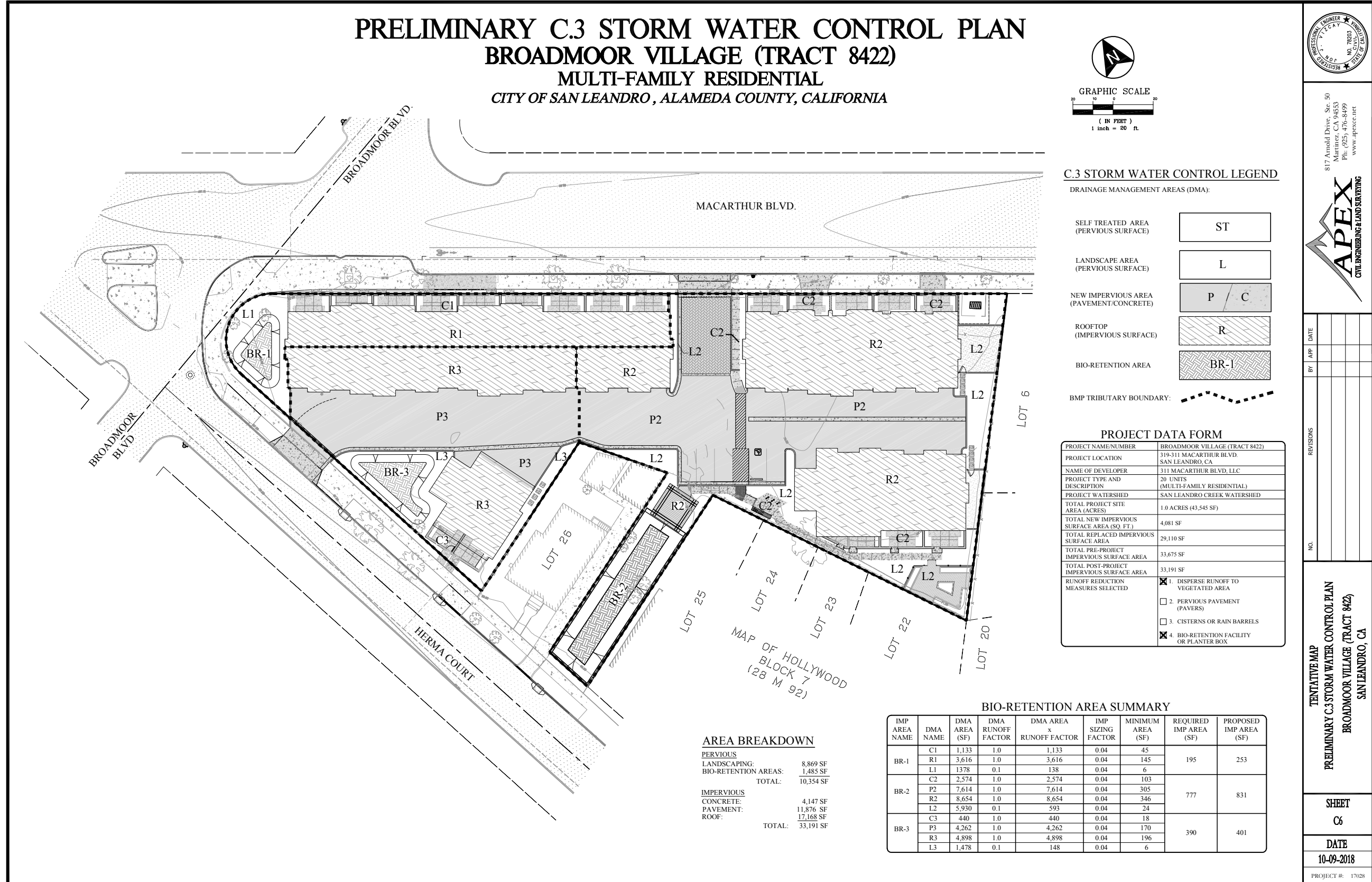

## PRELIMINARY C.3 STORM WATER CONTROL PLAN BROADMOOR VILLAGE (TRACT 8422) MULTI-FAMILY RESIDENTIAL CITY OF SAN LEANDRO, ALAMEDA COUNTY, CALIFORNIA

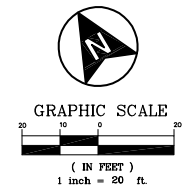

### C.3 STORM WATER CONTROL LEGEND

DRAINAGE MANAGEMENT AREAS (DMA):

SELF TREATED AREA (PERVIOUS SURFACE)	ST
LANDSCAPE AREA (PERVIOUS SURFACE)	L
NEW IMPERVIOUS AREA (PAVEMENT/CONCRETE)	P / C
ROOFTOP (IMPERVIOUS SURFACE)	R
BIO-RETENTION AREA	BR-1

BMP TRIBUTARY BOUNDARY:

### PROJECT DATA FORM

PROJECT NAME/NUMBER	BROADMOOR VILLAGE (TRACT 8422)
PROJECT LOCATION	319-311 MACARTHUR BLVD. SAN LEANDRO, CA
NAME OF DEVELOPER	311 MACARTHUR BLVD, LLC
PROJECT TYPE AND DESCRIPTION	20 UNITS (MULTI-FAMILY RESIDENTIAL)
PROJECT WATERSHED	SAN LEANDRO CREEK WATERSHED
TOTAL PROJECT SITE AREA (ACRES)	1.0 ACRES (43,545 SF)
TOTAL NEW IMPERVIOUS SURFACE AREA (SQ. FT.)	4,081 SF
TOTAL REPLACED IMPERVIOUS SURFACE AREA	29,110 SF
TOTAL PRE-PROJECT IMPERVIOUS SURFACE AREA	33,675 SF
TOTAL POST-PROJECT IMPERVIOUS SURFACE AREA	33,191 SF
RUNOFF REDUCTION MEASURES SELECTED	<input checked="" type="checkbox"/> 1. DISPERSE RUNOFF TO VEGETATED AREA <input type="checkbox"/> 2. PERVIOUS PAVEMENT (PAVERS) <input type="checkbox"/> 3. CISTERNS OR RAIN BARRELS <input checked="" type="checkbox"/> 4. BIO-RETENTION FACILITY OR PLANTER BOX

### AREA BREAKDOWN

<b>PERVIOUS</b>	
LANDSCAPING:	8,869 SF
BIO-RETENTION AREAS:	1,485 SF
<b>TOTAL:</b>	<b>10,354 SF</b>
<b>IMPERVIOUS</b>	
CONCRETE:	4,147 SF
PAVEMENT:	11,876 SF
ROOF:	17,168 SF
<b>TOTAL:</b>	<b>33,191 SF</b>

### BIO-RETENTION AREA SUMMARY

IMP AREA NAME	DMA NAME	DMA AREA (SF)	DMA RUNOFF FACTOR	DMA AREA x RUNOFF FACTOR	IMP SIZING FACTOR	MINIMUM AREA (SF)	REQUIRED IMP AREA (SF)	PROPOSED IMP AREA (SF)
BR-1	C1	1,133	1.0	1,133	0.04	45	195	253
	R1	3,616	1.0	3,616	0.04	145		
	L1	1378	0.1	138	0.04	6		
	C2	2,574	1.0	2,574	0.04	103		
BR-2	P2	7,614	1.0	7,614	0.04	305	777	831
	R2	8,654	1.0	8,654	0.04	346		
	L2	5,930	0.1	593	0.04	24		
	C3	440	1.0	440	0.04	18		
BR-3	P3	4,262	1.0	4,262	0.04	170	390	401
	R3	4,898	1.0	4,898	0.04	196		
	L3	1,478	0.1	148	0.04	6		



817 Arnold Drive, Ste. 50  
Martinez, CA 94553  
Ph: (925) 476-8499  
www.apexce.net



NO.	REVISIONS	BY	DATE

TENTATIVE MAP  
PRELIMINARY C.3 STORM WATER CONTROL PLAN  
BROADMOOR VILLAGE (TRACT 8422)  
SAN LEANDRO, CA

SHEET  
C6

DATE  
10-09-2018

PROJECT #: 17028



# EXHIBIT P.1 - TITLE

## COLOR & MATERIALS

ACCENT COLOR 2  
HARDIE PANEL VERT. SIDING  
COLOR : TIMBER BARK  
SMOOTH PANEL BOARD&BATTEN



ACCENT COLOR 3  
ENTRY DOORS  
SHERWIN WILLIAMS  
COLOR : SW2739  
CHARCOAL BLUE



ACCENT COLOR 4  
ENTRY DOORS  
SHERWIN WILLIAMS  
COLOR : SW6230  
RAINSTORM



TRIM COLOR  
DOOR&WINDOW TRIMS,  
CORBELS, KICKERS, RAILINGS  
SHERWIN WILLIAMS  
COLOR : SW7628  
WINDFRESH WHITE

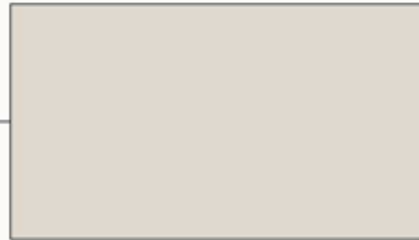

BRICK VENEER  
ELDORADO  
COLOR: HARTFORD  
TUNDRA BRICK W/CHISELED-EDGE WALL CAP

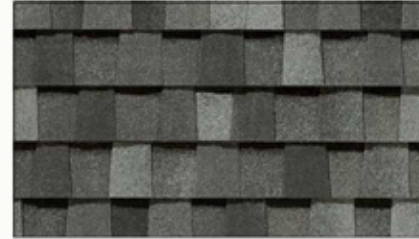

ROOF  
CERTAINTEED  
COLOR: THUNDERSTORM GRAY  
LANDMARK SERIES

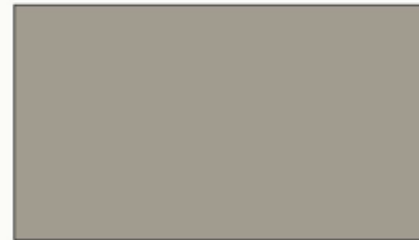

BODY COLOR 1  
SHERWIN WILLIAMS  
COLOR : SW7746  
RUSHING RIVER



BODY COLOR 2  
SHERWIN WILLIAMS  
COLOR : SW7016  
MINDFUL GRAY

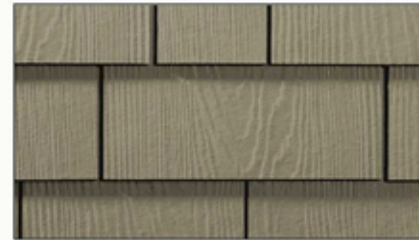

BODY COLOR 3  
HARDIE SHINGLE  
COLOR : MONTEREY TAUPE  
STRAIGHT-EDGE

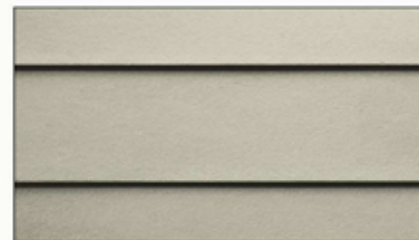

ACCENT COLOR 1  
HARDIEPLANK LAP SIDING  
COLOR : COBBLE STONE  
SMOOTH

BROADMOOR VILLAGE  
MACARTHUR BLVD.  
SAN LEANDRO, CA



Architecture | Planning | Interiors

444 Spear Street, Suite 105  
San Francisco, CA 94105  
www.hunthalejones.com

t. 415-512-1300  
f. 415-288-0288

SCHEME A

SCALE: 1/8"=1'-0"  
DATE: 06.12.2017  
PROJECT: 33505

# EXHIBIT P.2 - TITLE

## COLOR & MATERIALS

TRIM COLOR  
SHERWIN WILLIAMS  
COLOR : SW7628  
WINDFRESH WHITE

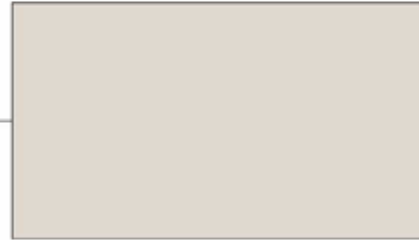

BRICK VENEER  
ELDORADO  
COLOR: HARTFORD  
TUNDRA BRICK W/CHISELED-EDGE WALL CAP



ROOF  
CERTAINTEED  
COLOR: THUNDERSTORM GRAY  
LANDMARK SERIES



BODY COLOR 1  
SHERWIN WILLIAMS  
COLOR : SW7746  
RUSHING RIVER



BODY COLOR 2  
SHERWIN WILLIAMS  
COLOR : SW7018  
DOVETAIL



BODY COLOR 3  
HARDIE SHINGLE  
COLOR : TIMBER BARK  
STAGGERED-EDGE



ACCENT COLOR 1  
ENTRY DOORS  
SHERWIN WILLIAMS  
COLOR : SW6230  
RAINSTORM

BROADMOOR VILLAGE  
MACARTHUR BLVD.  
SAN LEANDRO, CA



Architecture | Planning | Interiors

444 Spear Street, Suite 105  
San Francisco, CA 94105  
www.hunthalejones.com

t. 415-512-1300  
f. 415-288-0288

SCHEME B

SCALE: 1/8"=1'-0"  
DATE: 05.12.2017  
PROJECT: 33505

# EXHIBIT P.3 - TITLE

## COLOR & MATERIALS

ACCENT COLOR 1  
HARDIE PLANK LAP SIDING  
COLOR : MONTEREY TAUPE  
SMOOTH



ACCENT COLOR 2  
ENTRY DOORS  
SHERWIN WILLIAMS  
COLOR : SW2739  
CHARCOAL BLUE



TRIM COLOR  
SHERWIN WILLIAMS  
COLOR : SW7628  
WINDFRESH WHITE

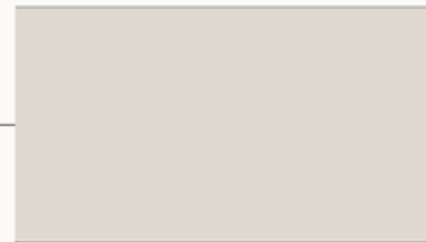

BRICK VENEER  
ELDORADO  
COLOR: HARTFORD  
TUNDRA BRICK W/CHISELED-EDGE WALL CAP

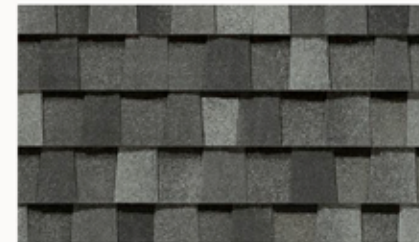

ROOF  
CERTAINTEED  
COLOR: THUNDERSTORM GRAY  
COMPOSITION DESIGNER



BODY COLOR 1  
SHERWIN WILLIAMS  
COLOR : SW7746  
RUSHING RIVER

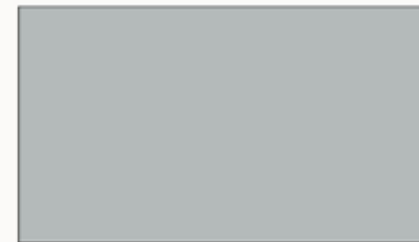

BODY COLOR 2  
SHERWIN WILLIAMS  
COLOR : SW7663  
MONORAIL SILVER



BODY COLOR 3  
SHERWIN WILLIAMS  
COLOR : SW9163  
TIN LIZZIE



BODY COLOR 4  
HARDIE PLANK LAP SIDING  
COLOR : COBBLE STONE  
SMOOTH

BROADMOOR VILLAGE  
MACHARTHUR BLVD.  
SAN LEANDRO, CA



Architecture | Planning | Interiors

444 Spear Street, Suite 105  
San Francisco, CA 94105  
www.hunthalejones.com

t. 415-512-1300  
f. 415-288-0288

SCHEME C

SCALE: 1/8"=1'-0"  
DATE: 05.12.2017  
REVISED DATE: 04.17.2018  
PROJECT: 33505

# EXHIBIT Q - SHADOW STUDY



SUMMER SOLSTICE 9AM JUNE 21



SUMMER SOLSTICE 12PM JUNE 21



SUMMER SOLSTICE 3PM JUNE 21

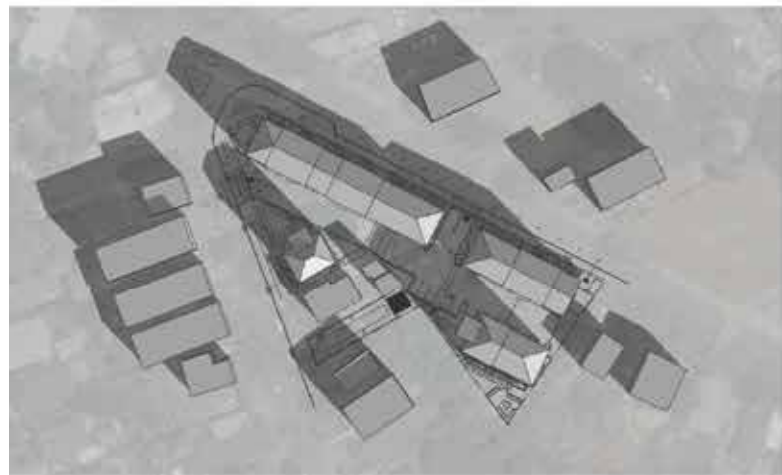

WINTER SOLSTICE 9AM DECEMBER 21

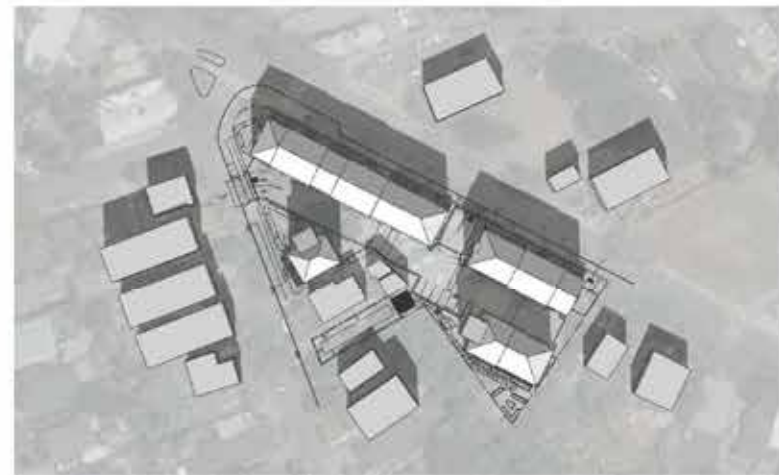

WINTER SOLSTICE 12PM DECEMBER 21

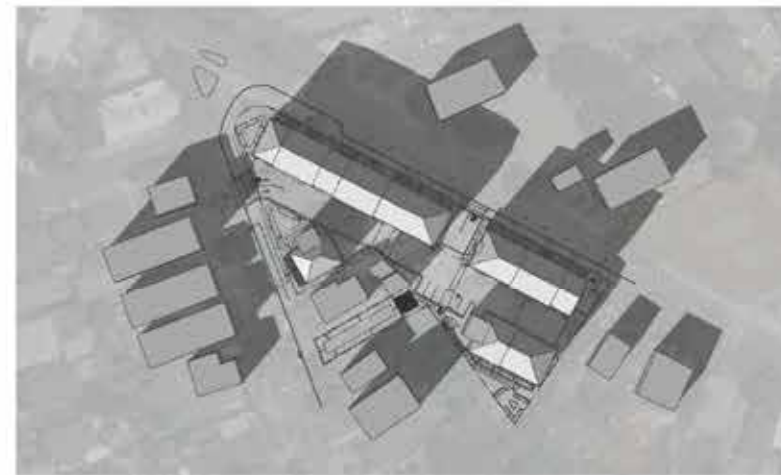

WINTER SOLSTICE 3PM DECEMBER 21

## BROADMOOR VILLAGE

311 MACARTHUR BLVD.  
SAN LEANDRO, CA



Architecture | Planning | Interiors

444 Spear Street, Suite 105  
San Francisco, CA 94105  
www.hunthalejones.com

t. 415-512-1300  
f. 415-288-0288

SHADOW STUDY

SS

SCALE: 1/8"=1'-0"  
DATE: 05.22.2017  
REVISED DATE: 01.02.2019  
PROJECT: 335005.00